

Panasonic

High Speed Laser Fax

Operating Instructions

Model No. **KX-FL503HK**



Please read these Operating Instructions before using the unit and save for future reference.

PFQX1509ZA WM0101EN0

Thank you for purchasing a Panasonic facsimile.

For your future reference

Date of purchase

Serial number

(found on the rear of the unit)

Dealer's name and address

Dealer's telephone number

Caution:

- Do not rub or use an eraser on the printed side of recording paper, as the print may smear.

Copyright:

This manual is copyrighted by Kyushu Matsushita Electric Co., Ltd. (KME) and its licensee. Under the copyright laws, this manual may not be reproduced in any form, in whole or part, without the prior written consent of KME and its licensee.

© Kyushu Matsushita Electric Co., Ltd. 2001

Important safety instructions

When using this unit, basic safety precautions should always be followed to reduce the risk of fire, electric shock, or personal injury.

1. Read and understand all instructions.
2. Follow all warnings and instructions marked on this unit.
3. Unplug this unit from power outlets before cleaning. Do not use liquid or aerosol cleaners. Use a damp cloth for cleaning.
4. Do not use this unit near water, for example near a bathtub, wash bowl, kitchen sink, or the like.
5. Place the unit securely on a stable surface. Serious damage and/or injury may result if the unit falls.
6. Do not cover slots and openings on the unit. They are provided for ventilation and protection against overheating. Never place the unit near radiators, or in a place where proper ventilation is not provided.
7. Use only the power source marked on the unit. If you are not sure of the type of power supplied to your home, consult your dealer or local power company.
8. For safety purposes this unit is equipped with a grounded plug. If you do not have this type of outlet, please have one installed. Do not use any type of adaptor plug to defeat this safety feature.
9. Do not place objects on the power cord. Install the unit where no one can step or trip on the cord.
10. Do not overload wall outlets and extension cords. This can result in the risk of fire or electric shock.
11. Never push any objects through slots in this unit. This may result in the risk of fire or electric shock. Never spill any liquid on the unit.
12. To reduce the risk of electric shock, do not disassemble this unit. Take the unit to an authorized service center when service is required. Opening or removing covers may expose you to dangerous voltages or other risks. Incorrect reassembly can cause electric shock when the unit is subsequently used.
13. Unplug this unit from the wall outlet and refer servicing to an authorized service center when the following conditions occur:
 - A. When the power supply cord or plug is damaged or frayed.
 - B. If liquid has been spilled into the unit.
 - C. If the unit has been exposed to rain or water.
 - D. If the unit does not work normally by following the operating instructions. Adjust only controls covered by the operating instructions. Improper adjustment may require extensive work by an authorized service center.
 - E. If the unit has been dropped or physically damaged.
 - F. If the unit exhibits a distinct change in performance.
14. During thunderstorms, avoid using telephones except cordless types. There may be a remote risk of an electric shock from lightning.
15. Do not use this unit to report a gas leak, when in the vicinity of the leak.

SAVE THESE INSTRUCTIONS

Safety instructions

CAUTION:

Laser radiation

- The printer of this unit utilizes a laser. Use of controls or adjustments or performance of procedures other than those specified herein may result in hazardous radiation exposure.

CLASS 1 LASER PRODUCT
KLASSE 1 LASER PRODUKT
CLASSE 1 LASER PRODUIT
CLASE 1 LÁSER PRODUCTO

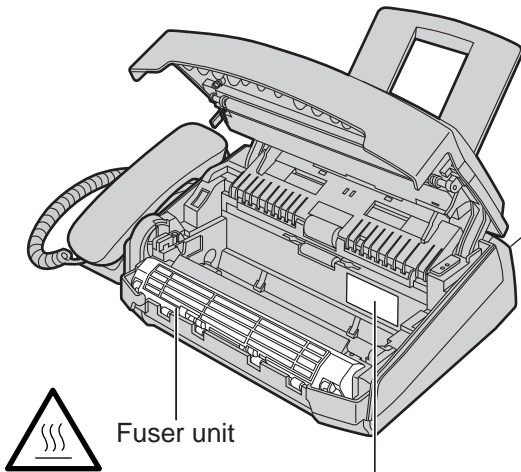

Fuser unit

DANGER: Invisible laser radiation when open and interlock defeated. AVOID DIRECT EXPOSURE TO BEAM.

ATTENTION: Rayonnement laser invisible dangereux en cas d'ouverture et lorsque la sécurité est neutralisée. EXPOSITION DANGEREUSE AU FAISCEAU.

VORSICHT: Unsichtbare Laserstrahlung, wenn Abdeckung geöffnet und Sicherheitsverriegelung überbrückt. NICHT DEM STRAHL AUSSETZEN.

PELIGRO: Cuando se abre y se invalida el bloqueo, se producen radiaciones invisibles de láser. EVÍTESE LA EXPOSICIÓN A TALES RAYOS.

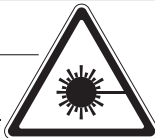

Toner cartridge

- Be careful of the following when you handle the toner cartridge.
 - If you ingest any toner, drink several glasses of water to dilute your stomach contents, and seek immediate medical treatment.
 - If any toner comes into contact with your eyes, flush them thoroughly with water, and seek medical treatment.
 - If any toner comes into contact with your skin, wash the area thoroughly with soap and water.

Drum unit

- Read the instructions on pages 12 and 13 before you begin installation of the drum unit. After you have read them, open the drum unit protection bag. The drum unit contains a photosensitive drum. Exposing it to light may damage the drum. Once you have opened the protection bag:
 - Do not expose the drum unit to light for more than 5 minutes.
 - Do not touch or scratch the green drum surface.
 - Do not place the drum unit near dust or dirt, or in a high humidity area.
 - Do not expose the drum unit to direct sunlight.

Fuser unit

- The fuser unit gets hot. Do not touch it.

Safety instructions

CAUTION:

Installation

- Never install telephone wiring during a lightning storm.
- Never install telephone jacks in wet locations unless the jack is specifically designed for wet locations.
- Never touch uninsulated telephone wires or terminals unless the telephone line has been disconnected at the network interface.
- Use caution when installing or modifying telephone lines.

WARNING:

- To prevent the risk of fire or electrical shock, do not expose this product to rain or any type of moisture.

OTHER INFORMATION:

- Keep the unit away from electrical noise generating devices, such as fluorescent lamps and motors.
- The unit should be kept free from dust, high temperature and vibration.
- The unit should not be exposed to direct sunlight.
- Do not place heavy objects on top of this unit.
- Do not touch the plug with wet hands.

Table of Contents

Initial Preparation

Accessories	Included accessories	8
	Accessory information	8
Help Button	Help function	9
Finding the Controls	Overview	10
	Location	11
Setup	Toner cartridge and drum unit	12
	Paper tray, document stacker and paper stacker	14
	Recording paper	15
	Connections	16
	Date and time, your logo and facsimile telephone number	17
Volumes	Adjusting volumes	21

Telephone

Automatic Dialing	Storing names and telephone numbers in ONE-TOUCH DIAL	22
	Storing names and telephone numbers in EASY DIAL	23
	Editing and erasing a stored name and number	24
	Making a voice call using ONE-TOUCH DIAL and EASY DIAL	26
Caller ID	Caller ID service from your phone company	27
	Viewing and calling back using caller information	28
	Confirming caller information using the Caller ID list	29
	Storing caller information in ONE-TOUCH DIAL and EASY DIAL	30
Voice Contact	Talking to the other party after fax transmission or reception	31

Fax

Sending Faxes	Sending a fax manually	32
	Sending a fax using ONE-TOUCH DIAL and EASY DIAL	33
	Documents you can send	34
	Reports for confirmation	35
	Broadcast transmission	36
Receiving Faxes	Setting the unit to receive faxes	40
	TEL mode (answering all calls manually)	42
	FAX ONLY mode (all calls are received as faxes)	43
	Using the unit with an answering machine	44
	TEL/FAX mode (receiving voice calls with rings and fax calls without rings when you are near the unit)	46
	Using with an answering machine and computer	48
	Extension telephone	48
	Turning the AUTO ANSWER mode on remotely	49
	Receive polling (retrieving a fax placed on another fax machine)	49
	Black list function	50
	Pager call - when the unit receives a fax	51

Copy

Copying	Making a copy	52
	Convenient way to make a copy	52

Programmable Features

Features	Programming.	54
Summary	Basic features	55
	Advanced features.	57

Help





Error Messages	Reports.	62
	Display	63
Operations	When a function does not work, check here before requesting help	65
	If a power failure occurs	68
Jams	Document jams - sending	69
	Recording paper jam.	70
	No feeding or multiple feeding occurs while sending	71
Cleaning	Cleaning the inside of the unit.	72
Replacement	Replacing the toner cartridge and the drum unit	74

General Information

Printed Reports	Reference lists and reports	77
Specifications	Technical data about this product	78
Index	Index.	80

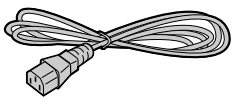
Accessories

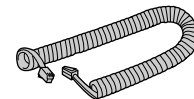
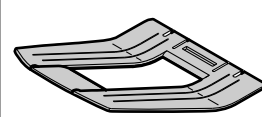
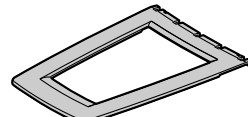
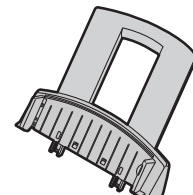
Included accessories

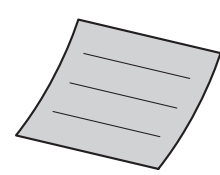
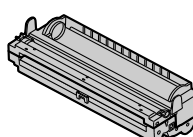
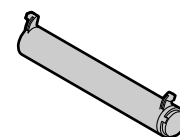
Power cord.....1 	Telephone line cord...1 	Handset.....1 	Handset cord.....1 
Paper stacker1 	Document stacker ...1 	Paper tray1 	Operating instructions...1 
Quick Start Sheet1 	Drum unit.....1 	Toner cartridge.....1 (complementary test starter cartridge)  <p>This cartridge can print approx. 800 sheets of A4 size paper with a 5% image area. Refer to image area on page 79. Please purchase a replacement toner cartridge Model No. KX-FA76A for continuous use of your unit.</p>	

- If any item is missing or damaged, check with the place of purchase.
- Save the original carton and packing materials for future shipping and transportation of the unit.

Accessory information

Model No.	Item	Usage	Specifications
KX-FA76A	Toner cartridge	For replacement. See page 74.	See page 79.
KX-FA77A	Drum unit	For replacement. See page 74.	See page 79.

Help function

You can print a quick reference for assistance as follows.

1 Press **HELP**.

Display:

2 Rotate **EASY DIAL** until the desired item is displayed.

1. How to set the date, time, your logo and fax number.

2. How to program the features.

3. How to store names in the EASY DIAL directory and how to dial them.

4. Help with problems receiving faxes.

5. How to use the copier function.

6. List of available reports.

7. How to use the Caller ID service.

3 Press **SET**.

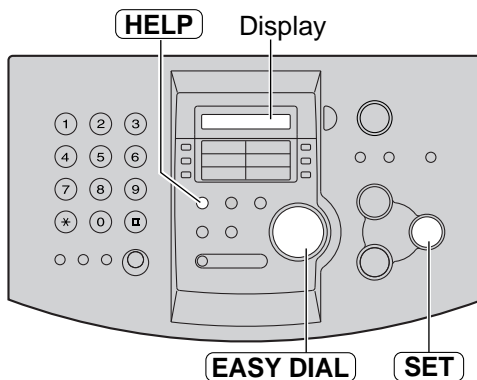

Finding the Controls

Overview

Handset

- To make or answer calls.

Speaker

(Left side of the unit)

Document guides

Paper tray

Recording paper entrance

Front cover

Document entrance

Document stacker

Front cover open button

Document exit

Paper stacker extender

Recording paper exit

Paper stacker

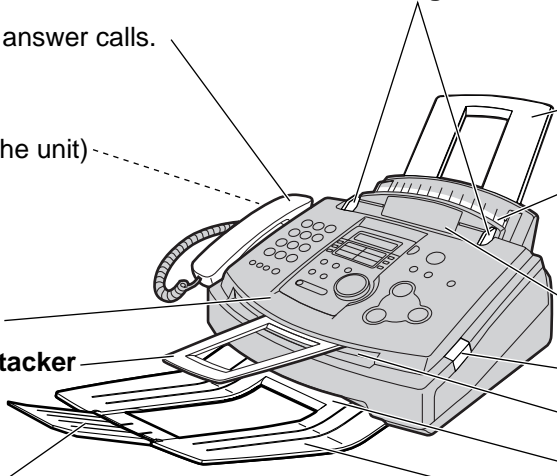

*The document stacker and paper stacker may not be shown in all illustrations.

Location

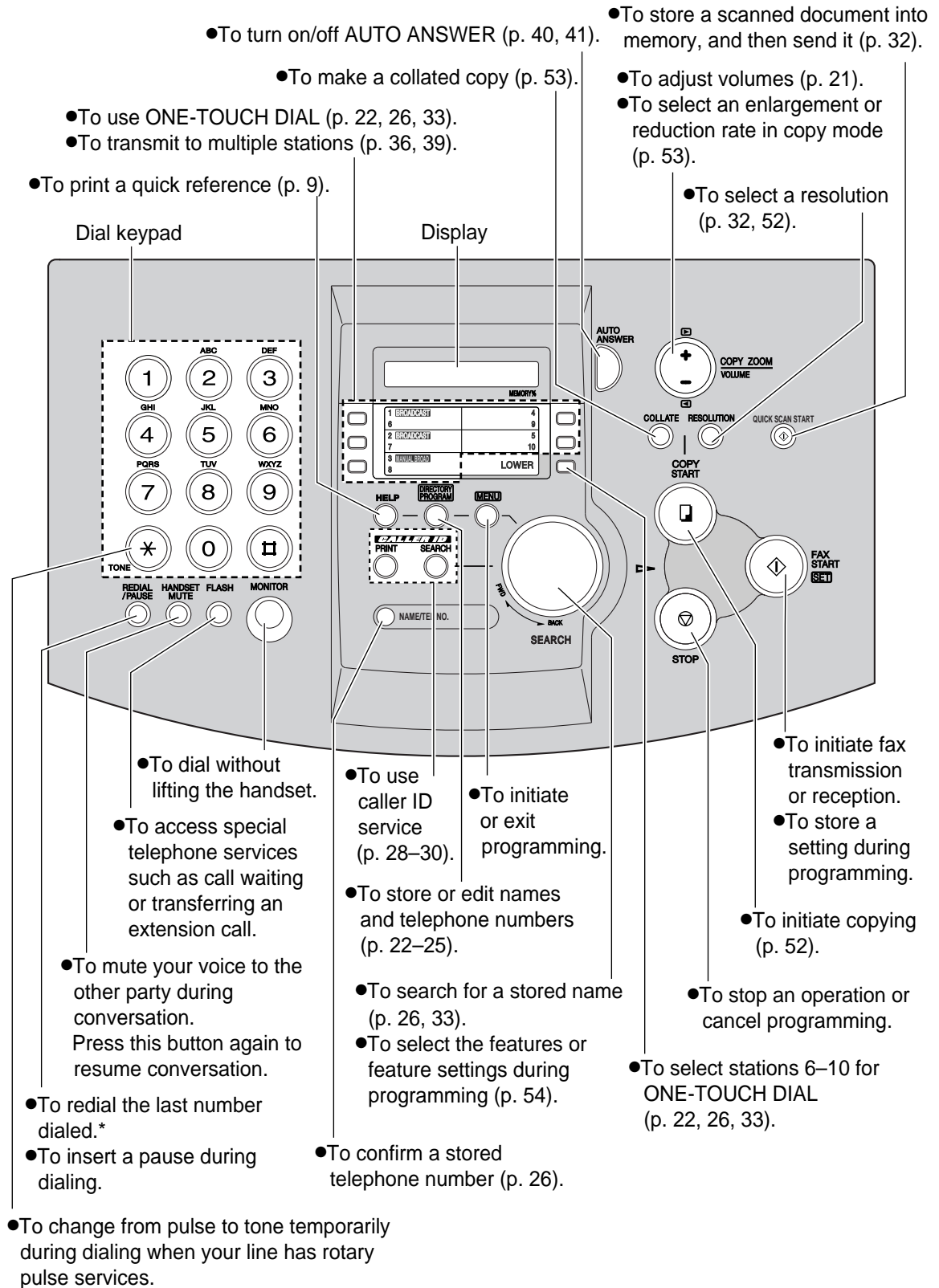

*If the line is busy when you make a voice call using the **MONITOR** button, the unit will automatically redial the number up to 9 times.

Setup

Toner cartridge and drum unit

Caution:

● Read the instructions below before you begin installation. After you have read them, open the drum unit protection bag. The drum unit contains a photosensitive drum. Exposing it to light may damage the drum. Once you have opened the protection bag:

- Do not expose the drum unit to light for more than 5 minutes.
- Do not touch or scratch the green drum surface.
- Do not place the drum unit near dust or dirt, or in a high humidity area.
- Do not expose the drum unit to direct sunlight.

- 1** Remove the toner cartridge and drum unit from the protection bags. Peel off the seal from the toner cartridge (①). Remove the protection bar from the drum unit (②).

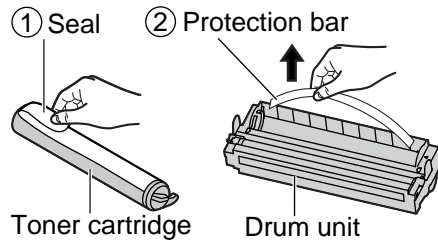

- 2** With Panasonic face up on the toner cartridge, match the red arrows on the cartridge and the drum unit.

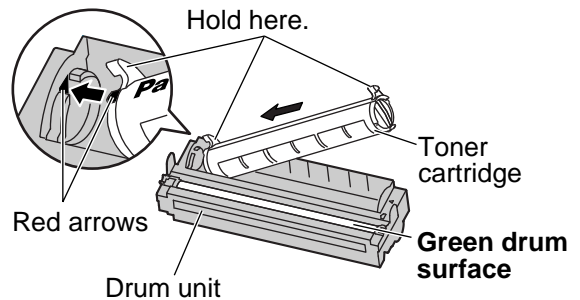

- 3** Slide the tab of the toner cartridge into the slot of the drum unit.

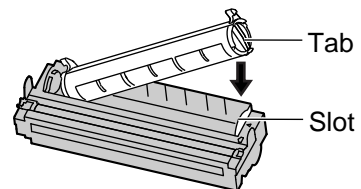

- 4a** Hold right side of the toner cartridge under the lip on the drum unit and...

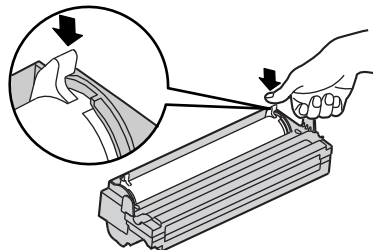

- 4b** turn the two levers on the toner cartridge with firm pressure.

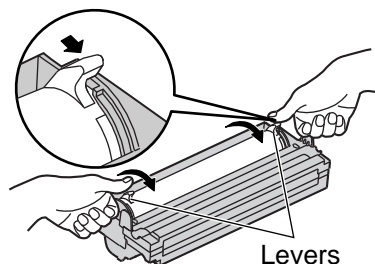

- 5** The toner cartridge is installed when the triangles match.

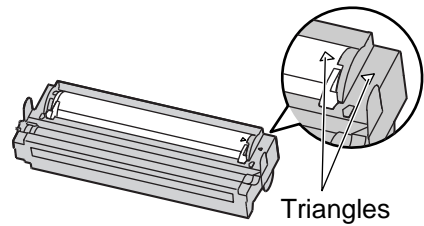

- 6** Tap on the toner cartridge several times to allow the toner to fall into the drum unit. Grab the tabs, and shake the drum and toner unit horizontally several times.

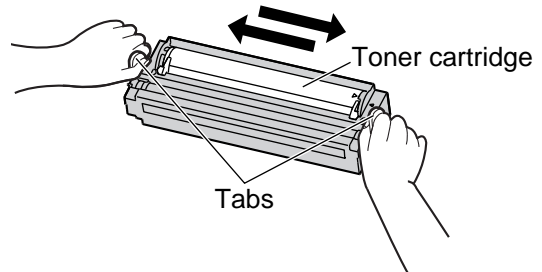

- 7** Push the front cover open button then open the front cover.

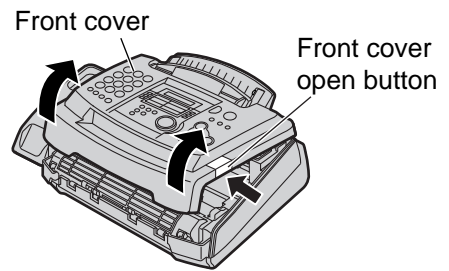

- 8** Install the drum and toner unit by holding the tabs.

- If the lower glass is dirty, clean it with a soft dry cloth.

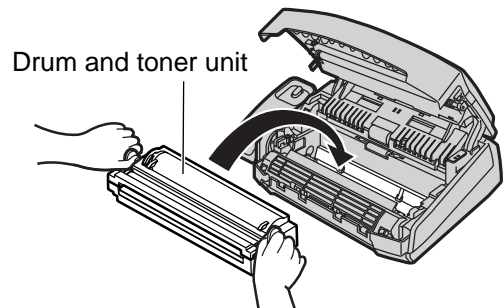
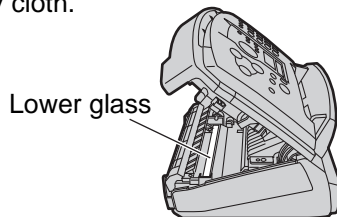

- 9** Close the front cover, until locked, by pushing down on both sides.

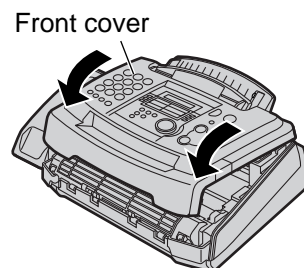

Toner save feature

- If you want to save on toner consumption, set the toner save setting to on (feature #79 on page 61). The toner cartridge will last approx. 40% longer. This feature may reduce print quality.

Setup

Paper tray, document stacker and paper stacker

Paper tray

Insert the paper tray into the two slots on the back of the unit (①).

Let it lean back until it clicks into place (②).

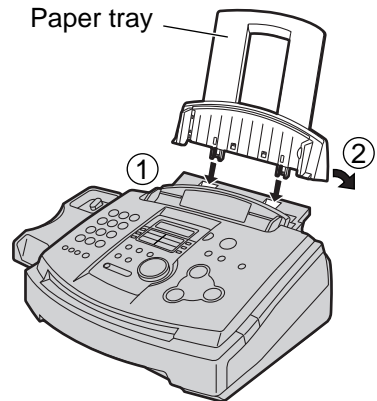

Document stacker

Align with the ribs on the document exit (①).

Pull the document stacker forward gently until it clicks into place (②).

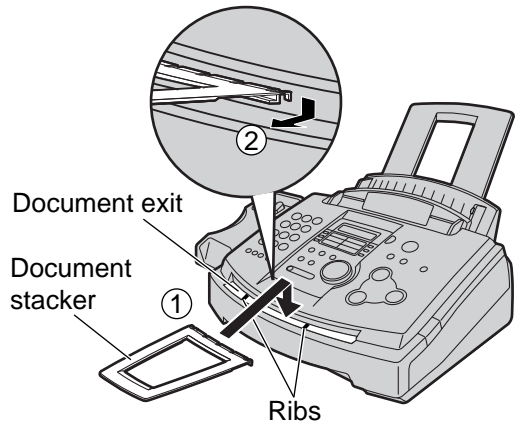

Paper stacker

Line up the slots in the paper stacker with the pegs on the bottom of the unit, then slide until locked.

Open the paper stacker extender.

- The paper stacker can hold approx. 100 sheets of printed paper. Remove the printed paper before they are filled on the paper stacker.

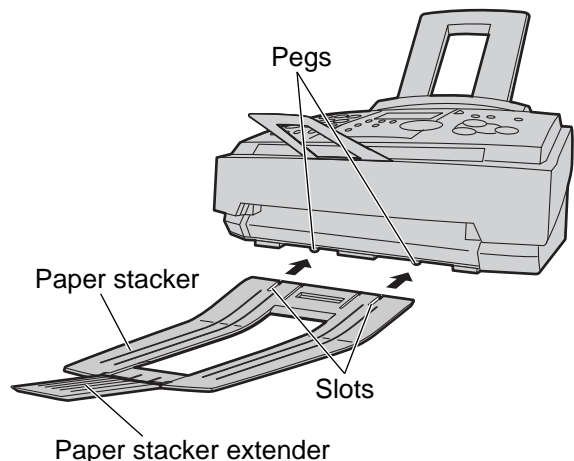

Note for installation:

- Do not place the unit in an area where the paper tray may be obstructed by a wall, etc.
- Document and recording paper will be ejected from the front of the unit. Do not place anything in front of the unit.

Recording paper

A4 size recording paper can be loaded. The unit can hold up to 150 sheets of 60 g/m² to 75 g/m² (16 lb. to 20 lb.) paper or 120 sheets of 90 g/m² (24 lb.) paper.

- 1 Fan the stack of paper to prevent a paper jam.
- 2 Insert the paper into the recording paper entrance.
 - The paper should not be over the tab.
 - If the paper is not inserted correctly, readjust the paper, or the paper may jam.

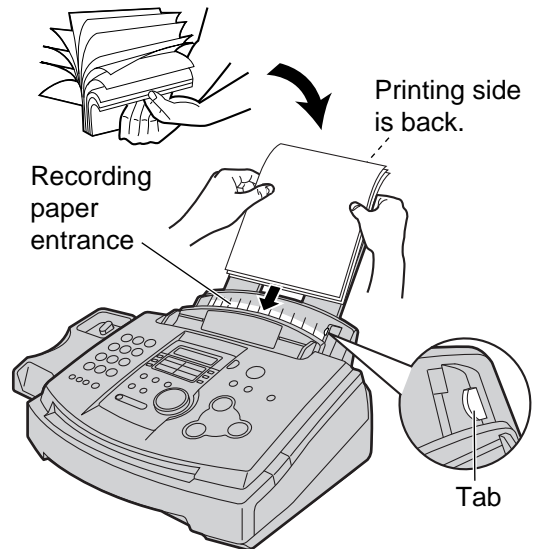
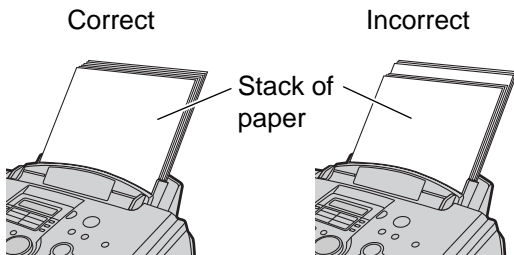

Note for recording paper:

- Avoid using paper with a cotton and/or fiber content that is over 20%, such as letterhead paper or paper used for resumes.
- Do not use different types or thicknesses of paper at the same time. This may cause a paper jam.
- Avoid extremely smooth or shiny paper that is highly textured.
- Avoid paper that is coated, damaged or wrinkled.

Note:

- Avoid double-sided printing.
- Do not use paper printed from this unit for double-sided printing with other copiers or printers, or the paper may jam.
- Some paper only accepts print on one side. Try using the other side of paper if you are not happy with the print quality.

Adding paper

1. Remove all of the installed paper.
2. Add paper to the removed paper and straighten.
3. Fan the stack of paper.
4. Insert the paper into the recording paper entrance.

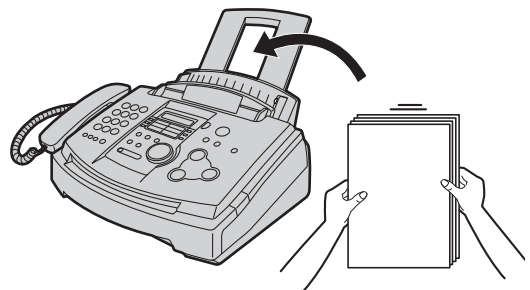

Setup

Connections

- 1 Connect the handset cord.
- 2 Connect the telephone line cord.
- 3 Connect the power cord.
 - When the power is turned on for the first time, the unit will print some basic information.

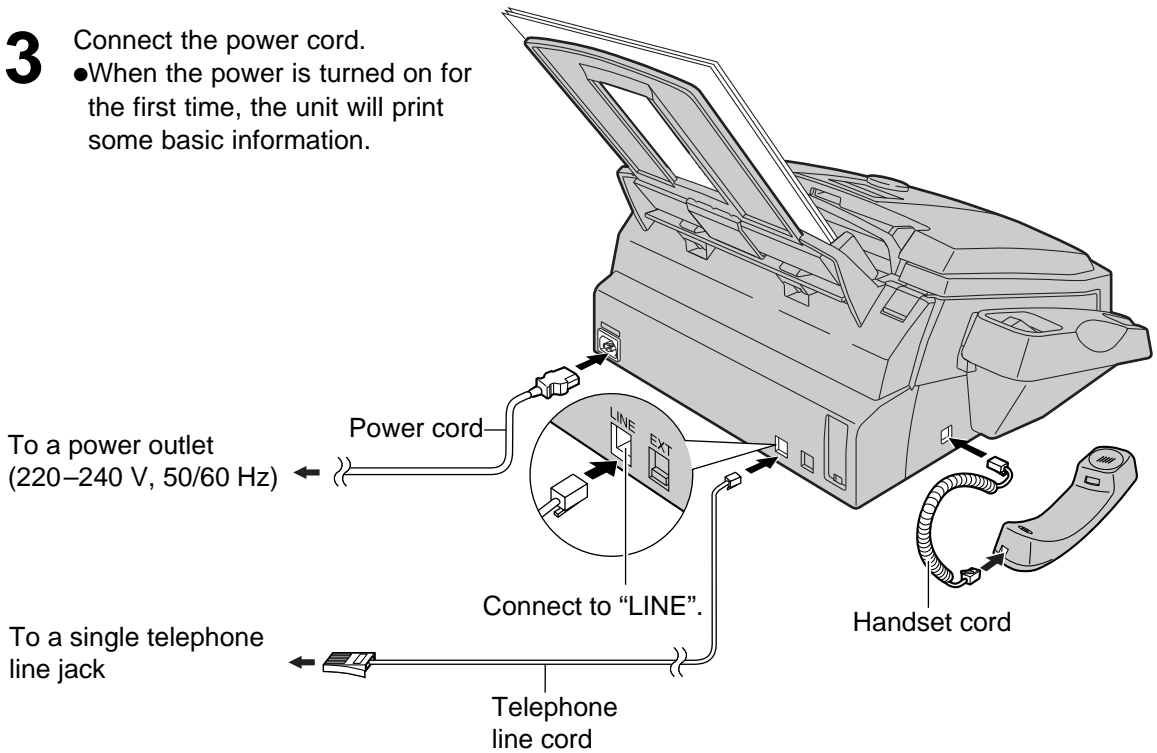

Caution:

- When you operate this product, the power outlet should be near the product and easily accessible.

Note:

- If you want to connect an answering machine to the unit, see page 44.

Date and time, your logo and facsimile telephone number

You should program the date and time, your logo and facsimile telephone number. This information will be printed on each page transmitted from your unit.

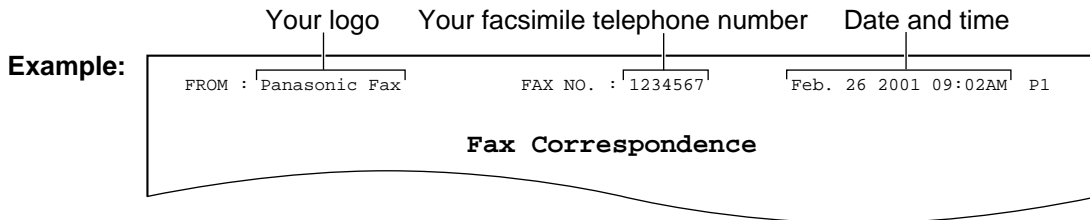

Setting the date and time

1 Press **MENU** .

Display: SYSTEM SET UP

2 Press **#**, then **0 1** .

SET DATE & TIME

3 Press **SET** .

Example: M:01/D:01/Y:01

└─ Cursor

4 Enter the correct month/day/year by selecting 2 digits for each, using the dial keypad.

Example: Aug. 10, 2001

Press **0 8 1 0 0 1** .

M:08/D:10/Y:01

5 Press **SET** .

Example: TIME: 12:00AM

6 Enter the correct hour/minute by selecting 2 digits for each, using the dial keypad. Press ***** to select "AM" or "PM".

Example: 3:15PM

1. Press **0 3 1 5** .

TIME: 03:15AM

2. Press ***** until "PM" is displayed.

TIME: 03:15PM

7 Press **SET** .

SETUP ITEM []

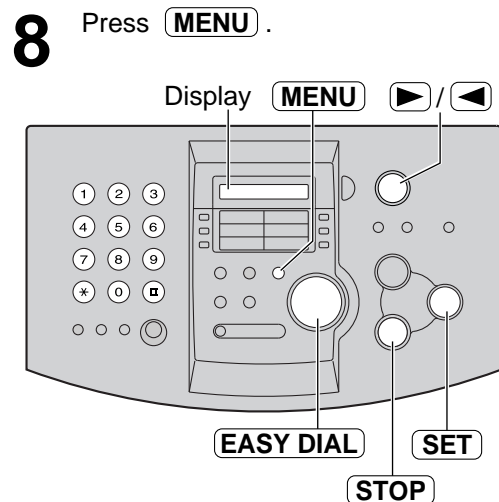

Note:

- You can enter the number by rotating **EASY DIAL** in steps 4 and 6. In this case, press **▶** to move the cursor.
- The accuracy of the clock is approximately ± 60 seconds a month.

To correct a mistake

- Press **▶** or **◀** to move the cursor to the incorrect number, and make the correction.
- If you press **STOP** while programming, the display will return to the previous one.

Setup

Setting your logo

The logo can be your company, division or name.

1 Press **MENU** .
Display: SYSTEM SET UP

2 Press **⇠**, then **0 2** .
YOUR LOGO

3 Press **SET** .
LOGO=

4 Enter your logo, up to 30 characters, using the dial keypad. See the next page for details.

Example: "Bill"

1. Press **2** twice.

LOGO=B
Cursor

2. Press **4** six times.

LOGO=Bi

3. Press **5** six times.

LOGO=Bi

4. Press **▶** to move the cursor to the next space and press **5** six times.

LOGO=Bill

5 Press **SET** .
SETUP ITEM []

6 Press **MENU** .

Note:

- You can enter your logo by rotating **EASY DIAL** (see the next page).

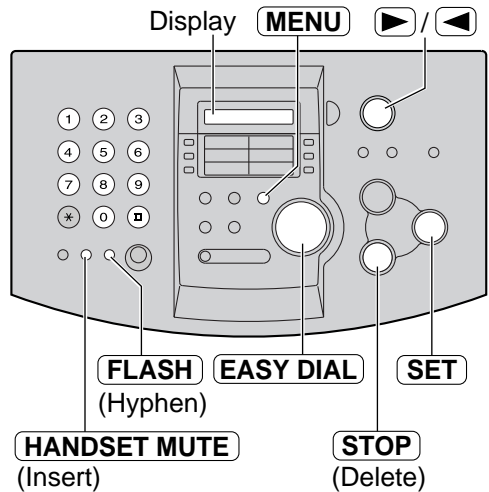

To change capital or lower case letters

Pressing the **⇠** key will change to capital or lower case alternatively.

1. Press **2** twice.

Display: LOGO=B

2. Press **4** three times.

LOGO=Bi

3. Press **⇠** .

LOGO=Bi

4. Press **5** three times.

LOGO=Bill

To correct a mistake

- Press **▶** or **◀** to move the cursor to the incorrect character, and make the correction.

To delete a character



- Move the cursor to the character you want to delete and press **STOP** .

To insert a character

1. Press **▶** or **◀** to move the cursor to the position to the right of where you want to insert the character.
2. Press **HANDSET MUTE (Insert)** to insert a space and enter the character.

To select characters with the dial keypad

Pressing the dial keys will select a character as shown below.

Keys	Characters
①	1 [] { } + - / = , . _ ` : ; ?
②	A B C a b c 2
③	D E F d e f 3
④	G H I g h i 4
⑤	J K L j k l 5
⑥	M N O m n o 6
⑦	P Q R S p q r s 7
⑧	T U V t u v 8
⑨	W X Y Z w x y z 9
⑩	0 () < > ! " # \$ % & ¥ * @ ^ ' →
☐	To change capital or lower case letter.
FLASH	Hyphen button (To insert a hyphen.)
HANDSET MUTE	Insert button (To insert one character or one space.)
STOP	Delete button (To delete a character.)
	▶ key (To move the cursor to the right.) To enter another character using the same number key, move the cursor to the next space.
	◀ key (To move the cursor to the left.)

To select characters using EASY DIAL

Instead of pressing the dial keys, you can select characters using EASY DIAL.

1. Rotate **EASY DIAL** until the desired character is displayed.
2. Press  to move the cursor to the next space.
 - The character displayed in step 1 is inserted.
3. Return to step 1 to enter the next character.

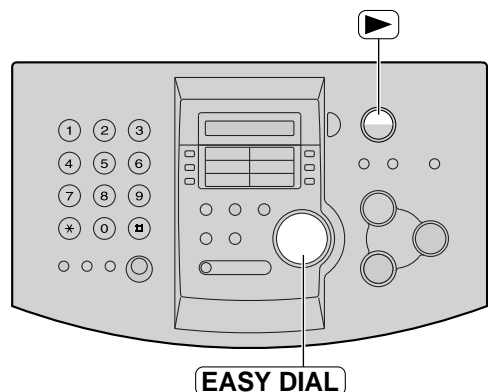

Display order of characters

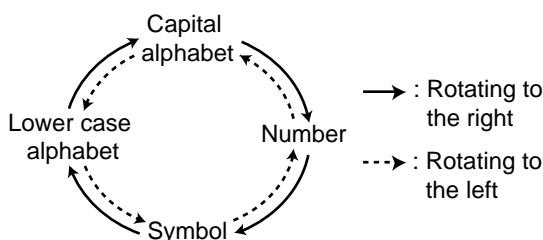

Setup

Setting your facsimile telephone number

1 Press **MENU**.

Display: SYSTEM SET UP

2 Press **▣**, then **0 3**.

YOUR FAX NO.

3 Press **SET**.

NO. =

4 Enter your facsimile telephone number, up to 20 digits, using the dial keypad.

Example: NO. = 1234567

5 Press **SET**.

SETUP ITEM []

6 Press **MENU**.

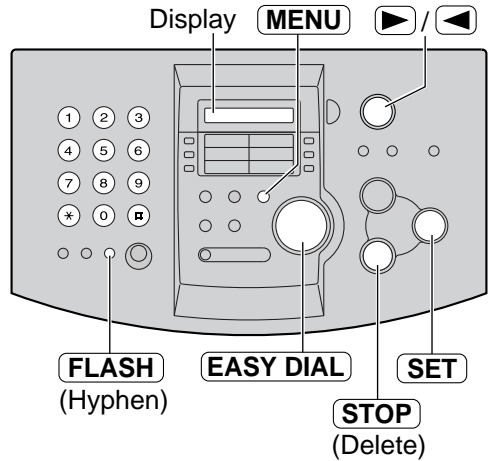

Note:

- You can enter your facsimile telephone number by rotating **EASY DIAL**. If you use **EASY DIAL**, press **▶** to move the cursor.
- The ***** button replaces the digit with a "+" and the **▣** button replaces it with a space.
Example (using the dial keypad): +234 5678
Press ***234▣5678**.
- To enter a hyphen in a telephone number, press **FLASH** (Hyphen).

To correct a mistake

- Press **▶** or **◀** to move the cursor to the incorrect number, and make the correction.



To delete a number

- Move the cursor to the number you want to delete and press **STOP**.

Adjusting volumes

Ringer volume

4 levels (high/middle/low/off) are available.

While the unit is idle, press  or .

● If any documents are in the document entrance, you cannot adjust the ringer volume. Confirm that there are no documents in the entrance.

■ To turn the ringer off:

1. Press  repeatedly until the following message is displayed.

Display:

RINGER OFF= OK?



YES: SET/NO: STOP

2. Press **SET**.

● To turn the ringer back on, press .

■ While the ringer volume is set to off:

The display will show the following message.

RINGER OFF

When a call is received, the unit will not ring and will display the following.

INCOMING CALL

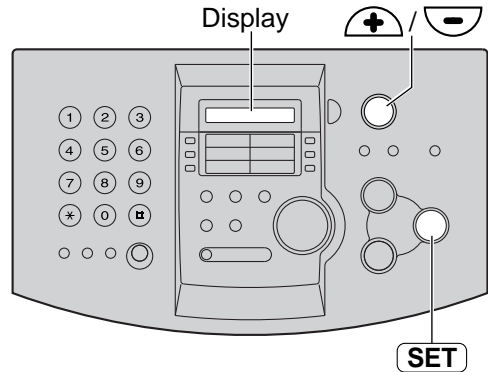

Melody ringer

● You can select one of the four melodies instead of the bell. Change the setting (feature #17 on page 56). The melody you selected will sound when the unit receives a call.

Handset receiver volume

5 levels (high to low) are available.

While using the handset, press  or .

Monitor volume

8 levels (high to low) are available.

While using the monitor, press  or .

Automatic Dialing

Storing names and telephone numbers in ONE-TOUCH DIAL

For rapid access to frequently dialed numbers, the unit provides 10 stations of ONE-TOUCH DIAL keys.

- ONE-TOUCH DIAL 1 to 3 can be alternatively used as broadcast keys (p. 36).

1 Press **DIRECTORY PROGRAM** .

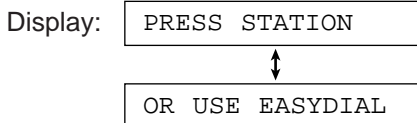

2 For ONE-TOUCH DIAL 1-3:
Press one of the ONE-TOUCH DIAL keys.

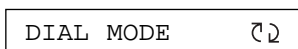

Press **SET** to go to the next prompt.

For ONE-TOUCH DIAL 4-5:
Press one of the ONE-TOUCH DIAL keys.

For ONE-TOUCH DIAL 6-10:
Press **LOWER**, then press one of the ONE-TOUCH DIAL keys.

3 Enter the name, up to 10 characters (see page 19 for instructions).

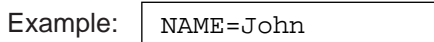

4 Press **SET** .

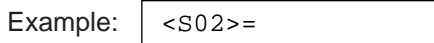

5 Enter the telephone number, up to 30 digits, using the dial keypad.

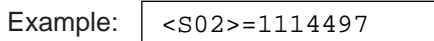

- If you want to enter a hyphen, press **FLASH** .

6 Press **SET** .

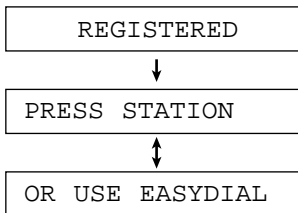

- To program other stations, repeat steps 2 to 6.

7 Press **STOP** to exit the program.

- If you press **DIRECTORY PROGRAM** instead of **STOP**, you can print the one-touch label card (see right).

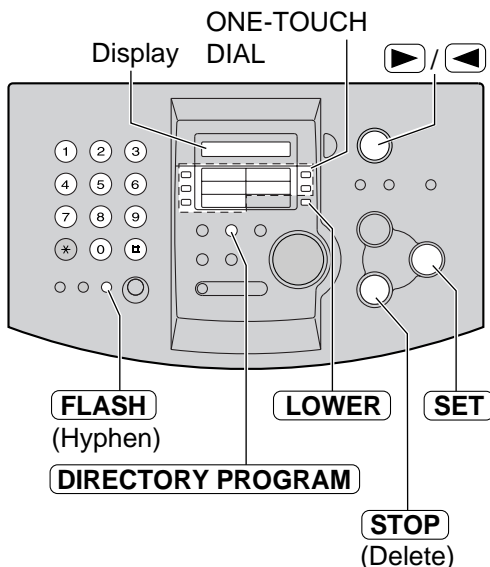

Helpful hint:

- You can confirm the stored items on the display (p. 26) or on the telephone number list (p. 77).

Note:

- A hyphen or a space entered in a telephone number counts as two digits.

To correct a mistake

- Press **▶** or **◀** to move the cursor to the incorrect character/number, and make the correction.

To delete a character/number

- Move the cursor to the character/number you want to delete, and press **STOP** .

To print the one-touch label card with stored names

Press **DIRECTORY PROGRAM** in step 7.

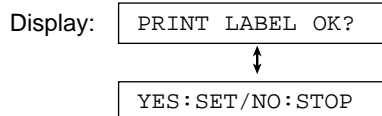

Press **SET** to start printing.

- Put the card in the ONE-TOUCH DIAL location.

Storing names and telephone numbers in EASY DIAL

For rapid access to frequently dialed numbers, the unit provides a EASY DIAL directory (100 stations).

1 Press **DIRECTORY PROGRAM** .

Display:

↓

2 Rotate **EASY DIAL** until the following is displayed.

3 Enter the name, up to 10 characters (see page 19 for instructions).

Example:

4 Press **SET** .

5 Enter the telephone number, up to 30 digits, using the dial keypad.

Example:

● If you want to enter a hyphen, press **FLASH** .

6 Press **SET** .

↓

● To program other items, repeat steps 3 to 6.

7 Press **DIRECTORY PROGRAM** to exit the program.

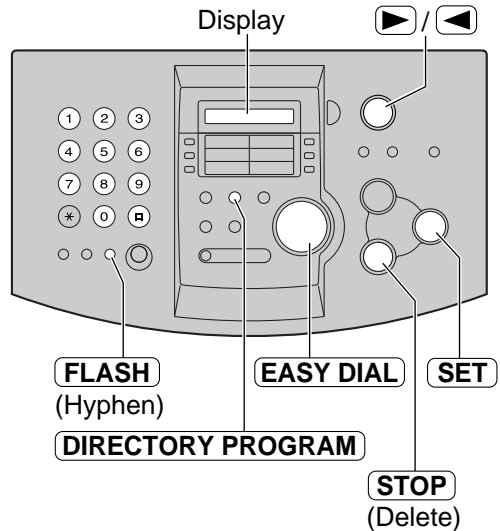

Helpful hint:

- You can confirm the stored items on the display (p. 26) or on the telephone number list (p. 77).

Note:

- When the following message is displayed in step 6, you can store only 5 more items.

Display:

- If there is no space to store new stations, the following message is displayed in step 1.

Erase unnecessary stations (p. 25).

- A hyphen or a space entered in a telephone number counts as two digits.

To correct a mistake

- Press **▶** or **◀** to move the cursor to the incorrect character/number, and make the correction.

To delete a character/number

- Move the cursor to the character/number you want to delete, and press **STOP** .

Automatic Dialing

Editing and erasing a stored name and number ==

Editing a stored name and number

You can edit a name or number stored in ONE-TOUCH DIAL and EASY DIAL.

- 1** Rotate **EASY DIAL** until the desired name is displayed.

Example:

means the station number for ONE-TOUCH DIAL

- 2** Press **DIRECTORY PROGRAM**.

- 3** Press ***** to select "EDIT".

- If you do not need to edit the name, skip to step 5.

- 4** Edit the name (see page 19 for instructions).

- 5** Press **SET**.

Example:

- If you do not need to edit the telephone number, skip to step 7.

- 6** Edit the telephone number. For further details, see page 23.

- 7** Press **SET**.

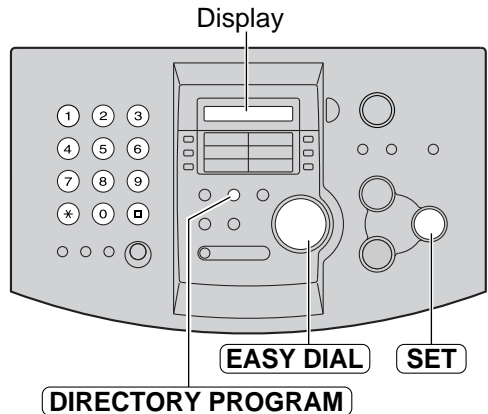

Erasing a stored station and item

You can erase ONE-TOUCH DIAL station and EASY DIAL item.

- 1 Rotate **EASY DIAL** until the desired name is displayed.

Example: Mary <S01>

- 2 Press **DIRECTORY PROGRAM**.

EDIT=* DELETE=#

- 3 Press **#** to select "DELETE".

DELETE OK?



YES:SET/NO:STOP

- To cancel erasing, press **STOP**.

- 4 Press **SET**.

DELETED

- The stored name and number are deleted.

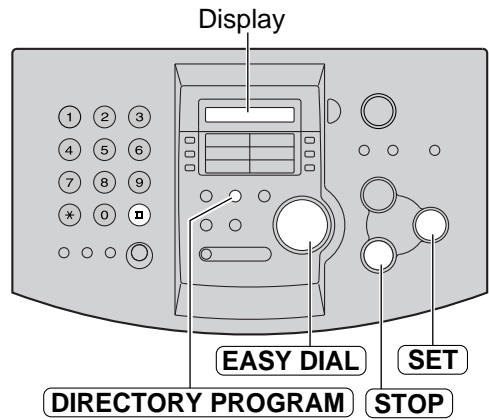

Automatic Dialing

Making a voice call using ONE-TOUCH DIAL and EASY DIAL

Before using this feature, program the desired names and telephone numbers into ONE-TOUCH DIAL and EASY DIAL (p. 22, 23).

Using ONE-TOUCH DIAL

1 Press **MONITOR** or lift the handset.

Display:

- Confirm that there are no documents in the document entrance.

2 For ONE-TOUCH DIAL 1–5:
Press the desired ONE-TOUCH DIAL key.

For ONE-TOUCH DIAL 6–10:
Press **LOWER**, then press the desired ONE-TOUCH DIAL key.

Example:

- The unit will start dialing automatically.

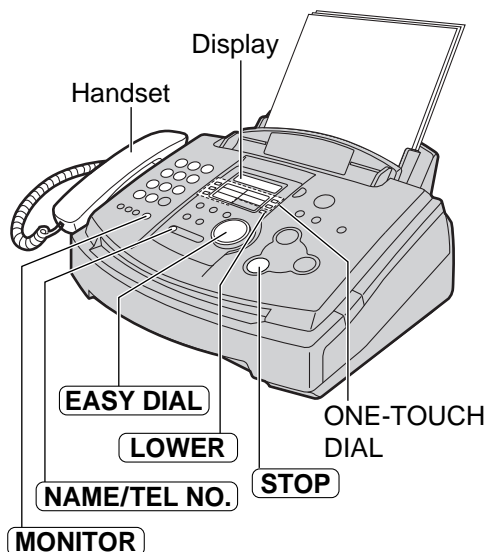

Using EASY DIAL

1 Rotate **EASY DIAL** until the desired name is displayed.

Example:

- If the desired name has not been stored, press **STOP** and dial the number manually.

2 Press **MONITOR** or lift the handset.
• The unit will start dialing automatically.

To confirm the stored telephone number on the display

1. Rotate **EASY DIAL** until the desired name is displayed.

Example:

means the station number for ONE-TOUCH DIAL

2. Press **NAME/TEL NO.**.

- To stop the confirmation, press **STOP**.
- To make a call, press **MONITOR** or lift the handset.

To search for a name by initial

Example: "Lisa"

1. Rotate **EASY DIAL** until any name is displayed.

Example:

2. Press **5** repeatedly until any name with the initial "L" is displayed (see the character table on page 19).

3. Rotate **EASY DIAL** to the right until "Lisa" is displayed.

- To stop the search, press **STOP**.
- To make a call, press **MONITOR** or lift the handset.

Note:

- When you want to search for symbols (not letters or numbers), press ***** in step 2.

Caller ID service from your phone company

This unit is compatible with the Caller ID service offered by your local telephone company. To use this feature, you must subscribe to the Caller ID service.

Set the following ring count settings to 2 or more rings beforehand.

—FAX ring count (feature #06 on page 55)

—TEL/FAX ring count (feature #78 on page 61)

How Caller ID is displayed

The calling party's name or telephone number will be displayed after the first ring.

You then have the option of whether or not to answer the call depending on the caller.

Example:

Chris Horner

The unit will automatically store the caller information (name, telephone number and the time of the call). You can view the caller information (p. 28) and print the caller ID list (p. 29).

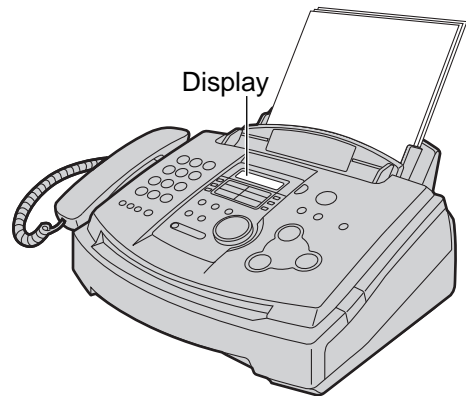

Note:

- If the unit is connected to a PBX (Private Branch Exchange) system, you may not receive the caller information. Consult your PBX supplier.
- If the unit cannot receive caller information, the unit will show the following.

OUT OF AREA

The caller dialed from an area which does not provide Caller ID service.

PRIVATE CALLER

The caller requested not to send caller information.

LONG DISTANCE

The caller made a long distance call.

Viewing and calling back using caller information

You can easily view caller information and call back.

Important:

- Calling back will not be available in the following cases.
 - The telephone number includes data other than numbers (i.e. * or #).
 - The caller information does not include a telephone number.

- 1 Press **CALLER ID SEARCH**.
Example (2 new calls are received):

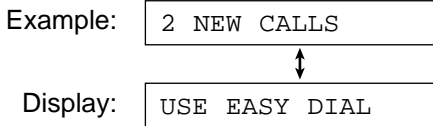

- 2 Rotate **EASY DIAL** to the right (clockwise).
 - The display will show the most recent caller's number.
 - If you rotate to the left, the display will show the reviewed calls.
 - To stop viewing, press **STOP**.

- 3 Press **MONITOR** or lift the handset to make a call.
 - The unit will start dialing automatically.
 - To send a fax – insert the document FACE DOWN and press **FAX START**.

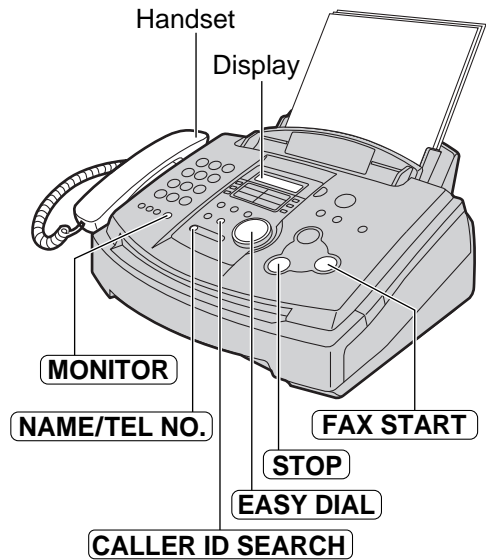

To display the caller's telephone number and the date/time of the call

Press **NAME/TEL NO.** repeatedly in step 2.

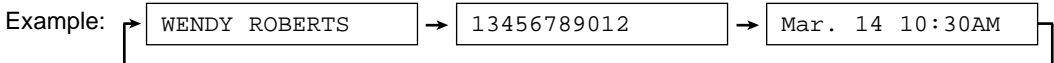

Display while viewing

NO NAME RCVD	When the unit could not receive a name.
END OF NEW CALL	After the last new call has been displayed.
END	After all calls have been displayed.
NO CALLER DATA	When no calls have been received.

Confirming caller information using the Caller ID list

The unit will store the 30 most recent caller information.

—To print manually, see below.

—To print automatically after every 30 new calls, activate feature #26 (p. 57).

Sample of a Caller ID list

CALLER ID LIST		Mar. 20 2001 09:19AM			
		YOUR LOGO :			
		YOUR FAX NO. :			
NO.	NAME	TELEPHONE NUMBER	TIME OF CALL	ANSWER	STATUS
01	WENDY ROBERTS	3456789012	Mar.14 10:30AM	FAX	!
02	ALLAN STONE	4567890123	Mar.13 08:35AM	FAX	*
03	MIKE TIMAR	9876543210	Mar.11 09:35AM	TEL	

Printing and erasing the Caller ID list

1 Press **CALLER ID PRINT** to start printing.

Display: PRINTING

- The display will show the following after printing.

ERASE ALL OK?



YES:SET/NO:STOP

2 Press **STOP** to exit the program, or press **SET** to erase all of the stored caller information.

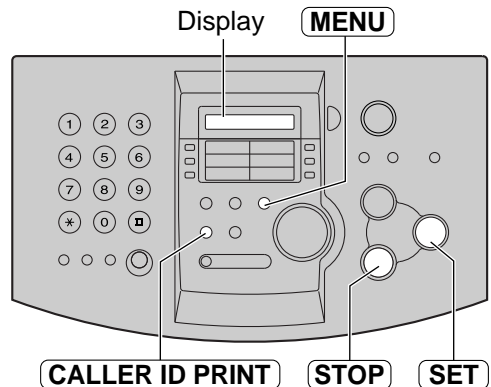

To erase caller information without printing

1. Press **MENU** three times.

Display: CALLER SET UP

2. Press **SET**.

CALL LIST ERASE

3. Press **SET**.

ERASE ALL OK?

- To cancel erasing, press **STOP**, then **MENU**.

4. Press **SET**.

ERASE COMPLETED

5. Press **STOP** to exit the program.

Storing caller information in ONE-TOUCH DIAL and EASY DIAL

Important:

- This feature is not available in the following cases.
 - The telephone number includes data other than numbers (i.e. * or #).
 - The caller information does not include a telephone number.

1 Press **CALLER ID SEARCH**.

Example:

↑

Display:

2 Rotate **EASY DIAL** until the number you want to store is displayed.

Example:

3 Press **DIRECTORY PROGRAM**.

↑

4 For **ONE-TOUCH DIAL 1-3**:
Press the desired ONE-TOUCH DIAL key.

Press **SET**.

Example:

Press **SET**.

Example:

For **ONE-TOUCH DIAL 4-5**:
Press the desired ONE-TOUCH DIAL key.

Press **SET**.

For **ONE-TOUCH DIAL 6-10**:
Press **LOWER**, then press the desired ONE-TOUCH DIAL key.

Press **SET**.

For EASY DIAL:

Rotate **EASY DIAL**.

Press **SET**.

5 Press **SET**.

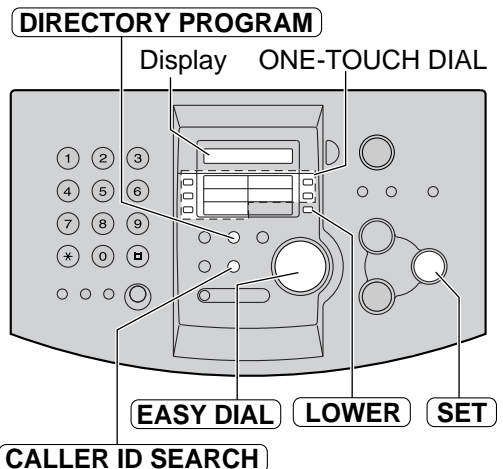

Note:

- You can confirm the stored items on the display (p. 26) or on the telephone number list (p. 77).
- You can only store a name of up to 10 characters long.
- To edit a name and number, see page 24.
- If you enter a new item into ONE-TOUCH DIAL, the previous entry will be overwritten.
- If you use ONE-TOUCH DIAL 1-3 as a broadcast station, you cannot store caller information.
- If the EASY DIAL directory is full, you cannot store caller information.

Talking to the other party after fax transmission or reception

You can talk to the other party after a fax message is completed. This will save the added expense and time of making another call.

This feature only works when the other party's fax machine is equipped with a voice contact feature.

Initiating voice contact

- 1 Press **MONITOR** while transmitting or receiving documents.

Display: VOICE STANDBY

- Your unit will call the other party with a distinctive ring.
- When the other party answers, your unit will emit a distinctive ring.

- 2 Lift the handset to start talking.

Note:

- If you initiate voice contact during transmission, the unit will call you with a distinctive ring after all of the documents have been transmitted.
- If you initiate voice contact during reception, the unit will call you with a distinctive ring after the current page of the document is received.

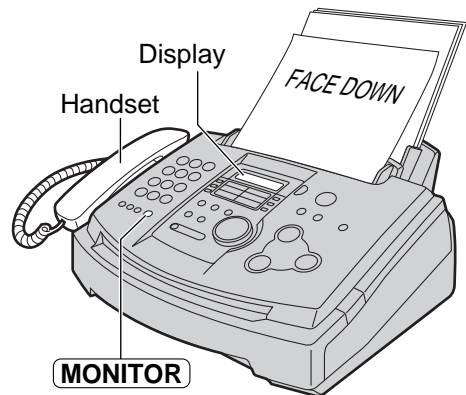

Receiving a request for voice contact

- 1 If the other party initiates voice contact, your unit will sound a distinctive ring and the following will be displayed.

PLEASE PICK UP

- 2 Lift the handset within 10 seconds of the distinctive ring to start talking.

Note:

- If you do not answer within 10 seconds of the distinctive ring, the line will be disconnected.

Sending Faxes

Sending a fax manually

- 1 Adjust the width of the document guides to the size of the document.
- 2 Insert the document (up to 15 pages) **FACE DOWN** until the unit grabs the document and a single beep is heard.

Display:

- 3 If necessary, press **RESOLUTION** repeatedly to select the desired setting (see below).

- 4 Press **MONITOR** or lift the handset.

- 5 Dial the fax number.

Example:

- 6 **When the fax tone is heard:**

Press **FAX START**, and replace the handset if you are using it.
OR

When the other party answers your call:
Using the handset, ask them to press their start button. When the fax tone is heard, press **FAX START** and replace the handset.

To stop transmission

Press **STOP**.

To redial the last number

Press **REDIAL/PAUSE**.

- If the line is busy, the unit will automatically redial the number up to 5 times.
- During redial, the following will be displayed.

Display:

- To cancel redialing, press **STOP**.

Convenient way to send a fax

You can dial the fax number first before inserting the document. This is convenient if the other party's number is indicated on the document.

1. Enter the fax number.
 - The handset must be on the cradle.
2. Insert the document.
3. Press **FAX START**.

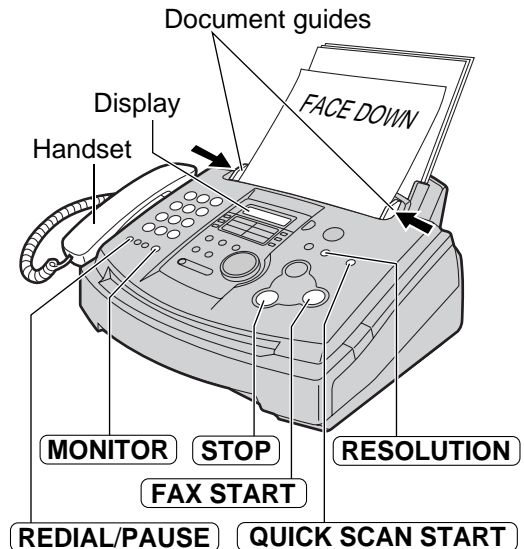

To select the resolution

Select the desired resolution according to the type of document.

STANDARD: For printed or typewritten originals with normal-sized characters.

FINE: For originals with small printing.

SUPER FINE: For originals with minute printing.

PHOTO: For originals containing photograph.

PHOTO WITH TEXT: For originals containing photograph and text.

- Using the "FINE", "SUPER FINE", "PHOTO" or "PHOTO WITH TEXT" setting will increase transmission time.
- If the resolution setting is changed during feeding, it will be effective from the next sheet.
- The "SUPER FINE" resolution only works with other compatible fax machines.

Sending from memory

You can press **QUICK SCAN START** instead of **FAX START** to scan the document into memory before sending. After storing, the unit will transmit the document.

- If the document exceeds the memory capacity (p. 78), sending will be canceled.

Sending a fax using ONE-TOUCH DIAL and EASY DIAL

Before using this feature, program the desired names and telephone numbers into ONE-TOUCH DIAL and EASY DIAL (p. 22, 23).

- 1 Adjust the width of the document guides to the size of the document.
- 2 Insert the document (up to 15 pages) **FACE DOWN** until the unit grabs the document and a single beep is heard.

Display:

- 3 If necessary, press **RESOLUTION** repeatedly to select the desired setting (p. 32).
- 4 Enter the fax number.
Using ONE-TOUCH DIAL 1-5:
Press the desired ONE-TOUCH DIAL key.
Using ONE-TOUCH DIAL 6-10:
Press **LOWER**, then press the desired ONE-TOUCH DIAL key.

Using EASY DIAL :
Display the desired name and press **FAX START**.

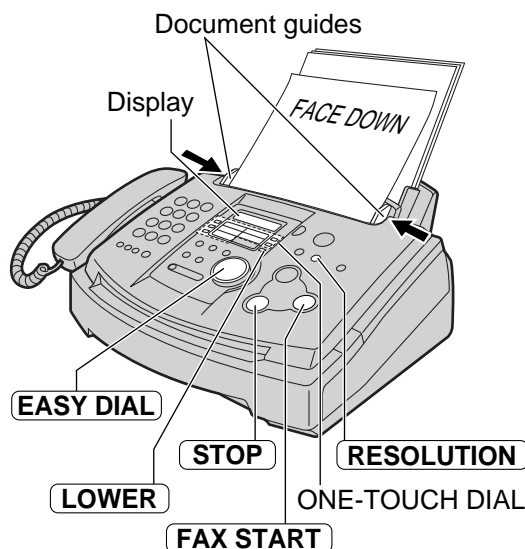

Fax auto redial

If the line is busy or if there is no answer, the unit will automatically redial the number up to 5 times.

- This feature is also available for delayed transmission (feature #25 on page 57).
- During redial, the following will be displayed.

Display:

- To cancel redialing, press **STOP**.

If your unit does not send a fax

- Confirm the stored telephone number on the display and check that the number dialed is answered by the other party's machine (p. 26).
- The connecting tone will be heard during dialing to tell you the status of the other party's machine (feature #76 on page 60).

Sending Faxes

Documents you can send

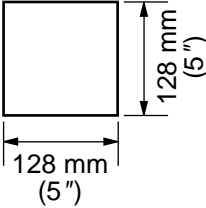
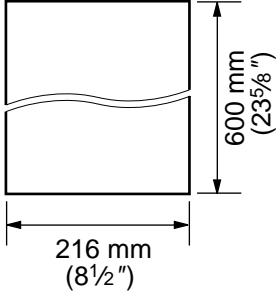
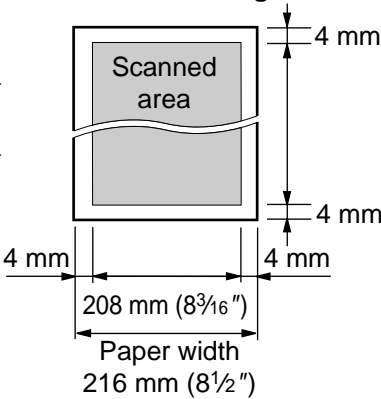
Minimum size	Maximum size	Effective scanning area	Document weight
			Single sheet: 45 g/m ² to 90 g/m ² (12 lb. to 24 lb.) Multiple sheets: 60 g/m ² to 75 g/m ² (16 lb. to 20 lb.)

Note:

- Remove clips, staples or other similar fasteners.
- Check that ink, paste or correction fluid has dried.
- Do not send the following types of documents. Use copies for fax transmission.
 - Chemically treated paper such as carbon or carbonless duplicating paper
 - Electrostatically charged paper
 - Heavily curled, creased or torn paper
 - Paper with a coated surface
 - Paper with a faint image
 - Paper with printing on the opposite side that can be seen through the front (e.g. newspaper)

To transmit more than 15 pages at a time

- Insert the first 15 pages of the document. Add the extra pages (up to 15) before the last page is fed into the unit.

Reports for confirmation

To confirm the communication results, the following reports are available.

Sending report

This report will provide you with a printed record of transmission results. To use this feature, activate feature #04 (p. 55).

Sample of a sending report

SENDING REPORT									
						Jan. 20 2001 09:19AM			
						YOUR LOGO :			
						YOUR FAX NO. :			
NO.	OTHER FACSIMILE	START TIME	USAGE TIME	MODE	PAGES	RESULT	*CODE		
01	2345678	Jan.20 09:18AM	00'51	SND	00	COMMUNICATION ERROR	43		

Communication message (p. 62)

Error code

Journal report

The unit stores the 30 most recent fax communication results. When a new communication occurs, the oldest communication result will be erased.

—To print manually, see page 77.

—To print automatically after every 30 new fax communications, activate feature #22 (p. 57).

Sample of a journal report

JOURNAL									
						Jan. 25 2001 11:22AM			
						YOUR LOGO :			
						YOUR FAX NO. :			
NO.	OTHER FACSIMILE	START TIME	USAGE TIME	MODE	PAGES	RESULT	*CODE		
01	3332222	Jan.21 07:14AM	00'45	SND	01	OK			
02	9998765	Jan.21 08:17AM	00'58	SND	02	OK			
03	John	Jan.21 09:18AM	00'48	RCV	01	OK			
04	55556666	Jan.21 10:25AM	02'45	SND	03	COMMUNICATION ERROR	43		
				SND	05	OK			
				SND	02	OK			

Communication message (p. 62)

Error code

Sending Faxes

Broadcast transmission

This feature is useful for sending the same document often to selected parties (up to 20 stations). First program the stations, then see page 39 for transmission.

- The broadcast function utilizes ONE-TOUCH DIAL 1–3. The one-touch dial function will be canceled.
- BROADCAST key 1 and 2 can accept ONE-TOUCH DIAL and EASY DIAL entries. MANUAL BROADCAST key can also accept manual dialing entries.

Programming the stations

1 Press **DIRECTORY PROGRAM**.

Display:

↑

↓

2 For **BROADCAST 1–2**:
Press the desired **BROADCAST** key.

Rotate **EASY DIAL** to select "BROADCAST".

Example:

For **MANUAL BROADCAST**:

Press **MANUAL BROAD**.

Rotate **EASY DIAL** to select "MANUAL BROADCAST".

3 Press **SET**.

4 Enter stations.
Using **ONE-TOUCH DIAL 1–5**:
Press the desired ONE-TOUCH DIAL key.

Example:

Using **ONE-TOUCH DIAL 6–10**:
Press **LOWER**, then press the desired ONE-TOUCH DIAL key.

Example:

Using **EASY DIAL** :
Display the desired name and press **SET**.

Example:

↓

Using the dial keypad (only for **MANUAL BROAD**):

Enter the fax number and press **SET**.

Example:

↓

- To enter other stations, repeat this step (up to 20 stations).

5 Press **SET** after programming all of the desired stations.

↓

↑

↓

- To program another broadcast key, repeat steps 2 to 5.

6 Press **STOP** to exit the program.

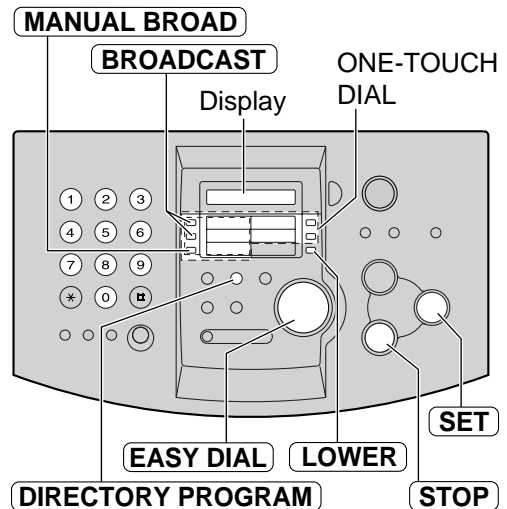

Note:

- If you enter the wrong station, press **STOP** after step 4 to erase the station.
- Confirm the stored items by printing a broadcast programming list (p. 77).

Adding a new station

- 1** Rotate **EASY DIAL** until the desired key name is displayed.
Example:
- 2** Press **DIRECTORY PROGRAM** .
- 3** Press ***** to select "ADD".
- 4** Rotate **EASY DIAL** until the desired name you want to add is displayed (only using EASY DIAL is available).
Example (EASY DIAL):
- Example (ONE-TOUCH DIAL-2):
- 5** Press **SET** .

↓
Example:
- To add other stations, repeat steps 4 and 5 (up to 20 stations).
- 6** Press **DIRECTORY PROGRAM** to exit the program.

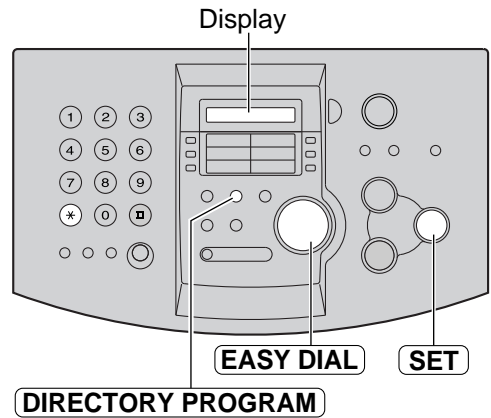

Sending Faxes

Erasing a stored station

- 1** Rotate **EASY DIAL** until the desired key name is displayed.
Example:
- 2** Press **DIRECTORY PROGRAM** .
- 3** Press **#** to select "DELETE".
- 4** Rotate **EASY DIAL** until the desired station you want to erase is displayed.
Example (EASY DIAL):

Example (ONE-TOUCH DIAL-3):
 - To cancel erasing, press **STOP** .
- 5** Press **SET** .

↕
- 6** Press **SET** .

↓
Example:
 - To delete other stations, repeat steps 4 to 6.
- 7** Press **DIRECTORY PROGRAM** to exit the program.

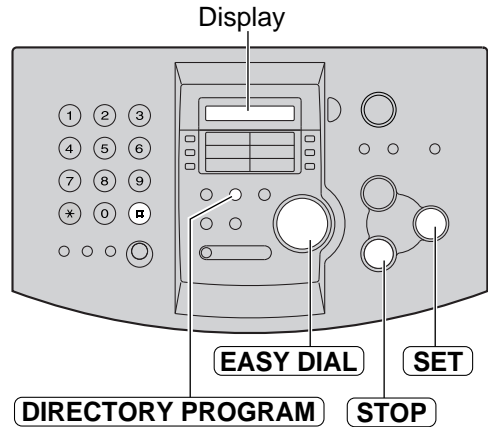

Sending the same document to pre-programmed parties

- 1 Insert the document **FACE DOWN**.
 - If necessary, press **RESOLUTION** repeatedly to select the desired setting (p. 32).
- 2 Press the desired **BROADCAST** (1-2) or **MANUAL BROADCAST**.
 - You can also use **EASY DIAL**. Display the desired key name, and press **FAX START**.

Example: <BROADCAST1>
 - The document will be fed into the unit and scanned into memory. The unit will then transmit the data to each station, calling each number sequentially.
 - After transmission, the stored document will be erased automatically, and the unit will automatically print a broadcast sending report (see below).



Note:

- If one of the stations is busy or does not answer, the station will be skipped. All skipped stations will be redialed up to 5 times after all of the other stations have been called.

To cancel the broadcast setting

1. Press **STOP** while the unit displays the following message.

Display: BROADCASTING

- The display will show the following.

SEND CANCELLED?
 ↓
YES: SET/NO: STOP

2. Press **SET**.

Sample of a broadcast sending report

BROADCAST REPORT 1						
NO.	OTHER FACSIMILE	START TIME	USAGE TIME	PAGES	RESULT	
					Jan. 10 2001 09:36AM	
					YOUR LOGO :	
					YOUR FAX NO. :	
01	Mike	Jan.10 09:31AM	01'10	02	OK	
02	Peter	Jan.10 09:33AM	01'08	02	OK	
03	Sam	Jan.10 09:34AM	01'09	02	OK	
04	Kim	Jan.10 09:35AM	01'10	02	OK	
TOTAL			004'37	008		

Receiving Faxes

Setting the unit to receive faxes

Use only as a fax

With answering machine

How you want the unit to receive calls

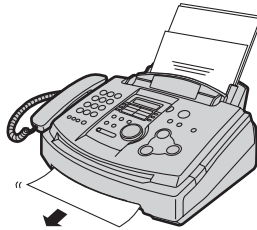

You have a separate telephone line just for faxes.

External telephone answering machine (not included)

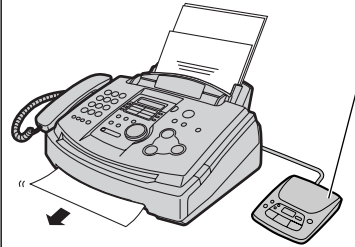

You want to use the fax machine with an answering machine.

You have to set this.

FAX ONLY mode (p. 43)

Turn AUTO ANSWER on by pressing **AUTO ANSWER**.

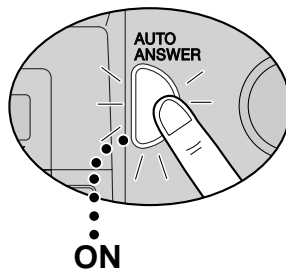

Activating an answering machine (p. 44)

Connect an external telephone answering machine and set the ring count of the answering machine to less than 4.

- Set the ring count in FAX ONLY mode of the fax machine to more than 4, if you use with AUTO ANSWER on.

This is how the unit will operate.

When receiving calls:
All incoming calls will be answered as faxes.

When receiving voice calls:
The answering machine will record voice messages.

When receiving fax calls:
The fax machine will disconnect the answering machine and receive documents.

Use as telephone/ automatic fax

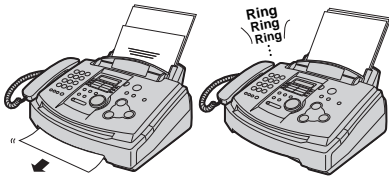

You want to answer
the voice call yourself
and receive fax calls
without rings.

Mostly voice calls

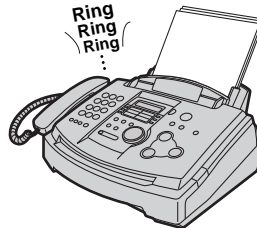

You plan to answer
the calls yourself.

Other options

With a PC

If you have a
computer attached
to the same
telephone line, see
page 48.

Remote fax activation

You can also
receive a fax using
an extension
telephone. While
hearing a fax
calling tone with an
extension
telephone, press
[*][*][*][9]
(pre-selected fax
activation code) to
receive a fax
(p. 48).

TEL/FAX mode (p. 46)

Set feature #77 to "TEL/FAX" (p. 61).
Turn AUTO ANSWER on by
pressing **AUTO ANSWER**.

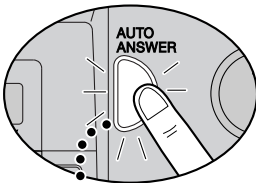

ON

TEL mode (p. 42)

Turn AUTO ANSWER off by
pressing **AUTO ANSWER**.

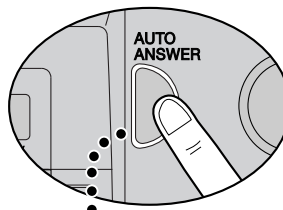

OFF

When receiving voice calls:

The unit will ring.

When receiving fax calls:

The unit will receive fax
documents without ringing.

When receiving calls:

You have to answer all calls
manually.

To receive a fax document,
press **FAX START** for
each fax call.

Receiving Faxes

TEL mode (answering all calls manually)

Activating TEL mode

If the AUTO ANSWER light is on, turn it off by pressing **AUTO ANSWER**.

Display: TEL MODE

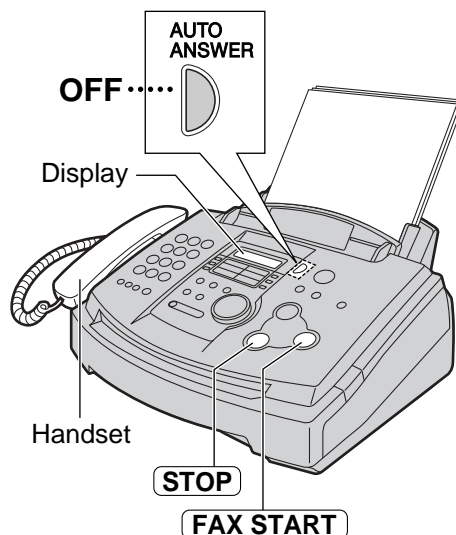

Receiving a fax manually

- 1** When the unit rings, lift the handset to answer the call.
- 2** When:
 - document reception is required,
 - a fax calling tone (slow beep) is heard, or
 - no sound is heard,press **FAX START**.

CONNECTING.....

- 3** Replace the handset.
 - The unit will start fax reception.

To stop receiving

Press **STOP**.

Friendly reception feature

When you answer a call and hear a fax calling tone (slow beep), the unit will automatically start fax reception.

- If this feature is not required, set feature #46 to off (p. 59).

Auto reduction feature

If the other party sends a document that is longer than your recording paper, your unit will reduce the receiving document to the proper size and print it. If you want to print the original size, set feature #37 to off (p. 58).

Fax reception in memory

When a printing problem is detected, the unit will temporarily store the received document into memory.

While the document is in memory:

- the display will show an error message and the following message alternately,

Display: FAX IN MEMORY

- slow beeps will sound if feature #44 is set to on (p. 59).

- Follow the instructions on pages 63 and 64 to solve the problem.
- For memory capacity, see page 78.

FAX ONLY mode (all calls are received as faxes)

Activating FAX ONLY mode

1 Set feature #77 to "FAX ONLY" (p. 61).

2 If the AUTO ANSWER light is off, turn it on by pressing **AUTO ANSWER**.

Display: FAX ONLY MODE

- The unit will automatically answer all calls and only receive fax documents.

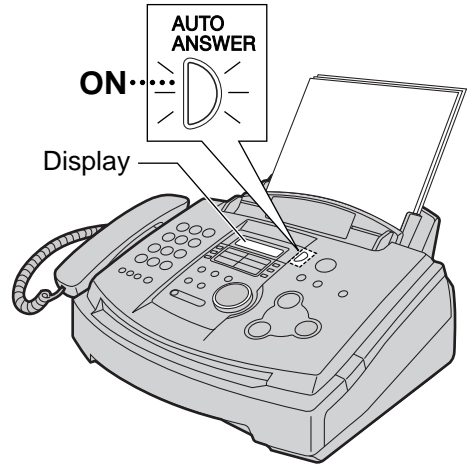

Note:

- The number of rings before a call is answered in the FAX ONLY mode can be changed (feature #06 on page 55).
- This mode should not be used with a telephone line which is used for both voice and fax calls. Fax communication will be attempted even if someone is trying to call you.

If you have a telephone line just for faxes, we recommend the following setup.

Example: One telephone line is used for voice calls and a separate telephone line for faxes.

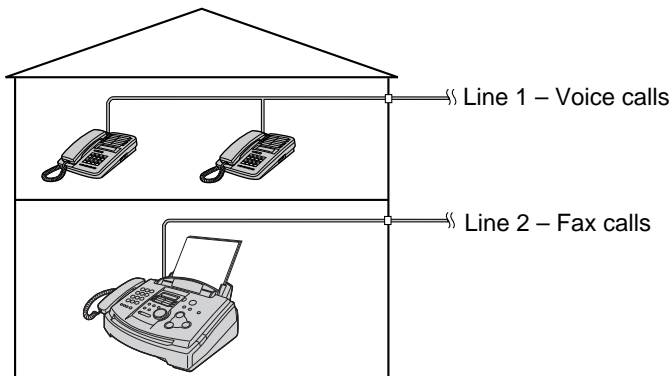

Only a fax machine is connected.

Receiving Faxes

Using the unit with an answering machine

Setting up the fax machine and an answering machine

- 1 Connect the answering machine.

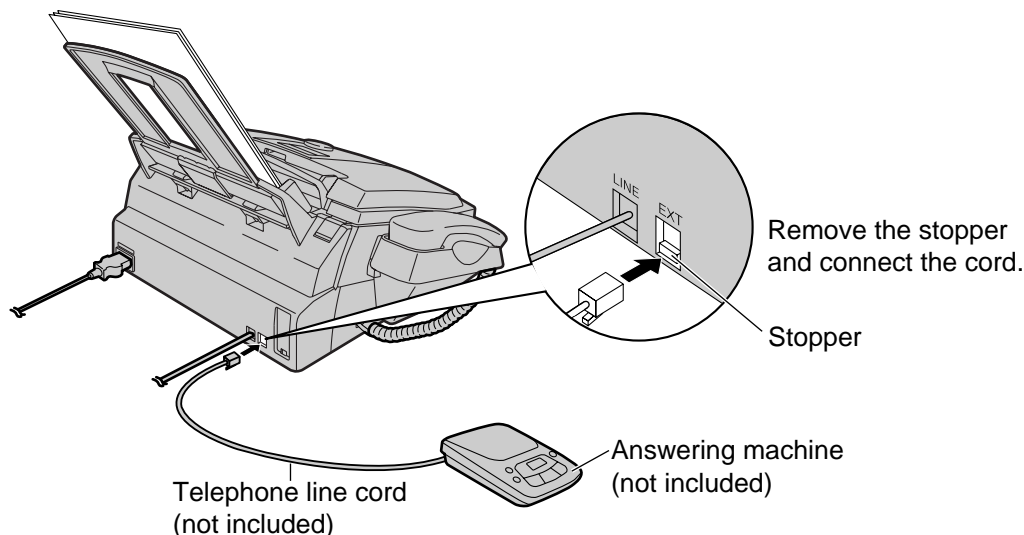

- 2 Set the number of rings on the answering machine to less than 4.
 - This will allow the answering machine to answer the call first.
- 3 Record a greeting message on the answering machine.

Example: *"This is (your name, business and/or telephone number). We are unable to answer the phone right now. To send a fax, start transmission. To leave a message, please speak after the beep. Thank you."*

 - We recommend you record your message around 10 seconds long and not to pause for more than 4 seconds during the message. Otherwise, both machines will not function correctly.
- 4 Activate the answering machine.
- 5 Set the receive mode of the fax machine to TEL mode (p. 42) or FAX ONLY mode (p. 43).
 - If you set to FAX ONLY mode, **set the ring count in FAX ONLY mode to more than 4 (feature #06 on page 55)**. Using FAX ONLY mode will allow you to receive faxes if the answering machine is full.
- 6 Check the remote access code of the answering machine and program the same code into the remote operation ID of the fax machine. See feature #12 on page 56.

How the fax machine and answering machine work

Receiving voice calls

The answering machine will record voice messages automatically.

Receiving fax calls

The fax machine will receive documents automatically when the machine detects a fax calling tone.

Receiving a voice message and fax document in one call

The answering machine will record the voice message first. The fax machine will then be activated by the caller's request and will receive the document.

Note:

- Every time the fax machine receives a document, a silent pause or fax tone may be recorded on the answering machine.

Receiving a voice message and fax document in one call

The caller can leave a voice message and send a fax document during the same call. Inform the caller of the following procedure beforehand.

1. The caller calls your fax machine.
 - The answering machine will answer the call.
2. The caller can leave a message after the greeting message.
3. The caller presses (pre-selected fax activation code).
 - The fax machine will activate the fax function.
4. The caller presses the start button to send a document.

Note:

- The fax activation code can be changed in feature #41 (p. 59).
- If the wrong fax activation code is entered, the caller must wait at least 5 seconds to reenter the correct code.

Receiving Faxes

TEL/FAX mode (receiving voice calls with rings and fax calls without rings when you are near the unit)

Use this mode when you are always near the fax machine, and want to receive faxes without the unit ringing. When a call is received, the fax machine will work as follows. To set TEL/FAX mode, see below.

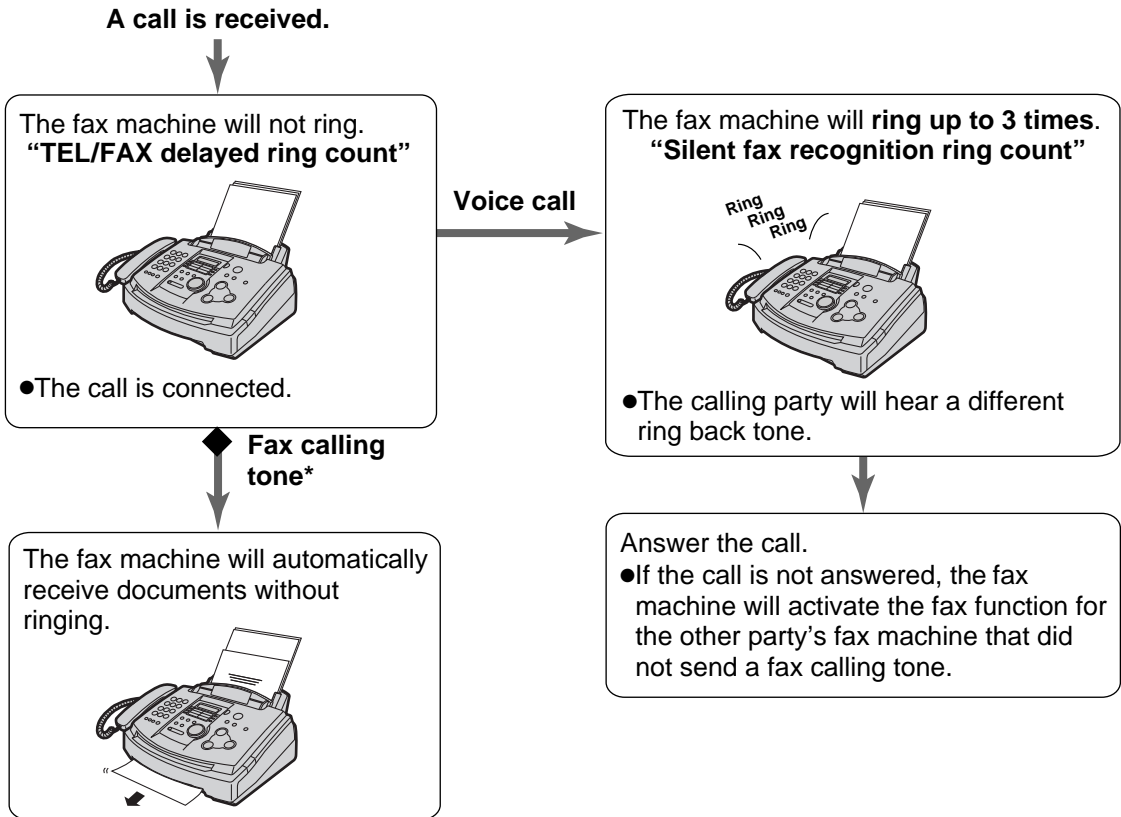

* A fax calling tone is automatically generated by the sending fax machine. Some fax machines do not have this capability.

Note:

- The fax machine will display the following when a call is received.

Display: INCOMING CALL

- The ringer should be on (p. 21).

To set TEL/FAX mode

1. Set feature #77 to “TEL/FAX” (p. 61).
2. If the AUTO ANSWER light is off, turn it on by pressing AUTO ANSWER.



When an extension telephone is connected

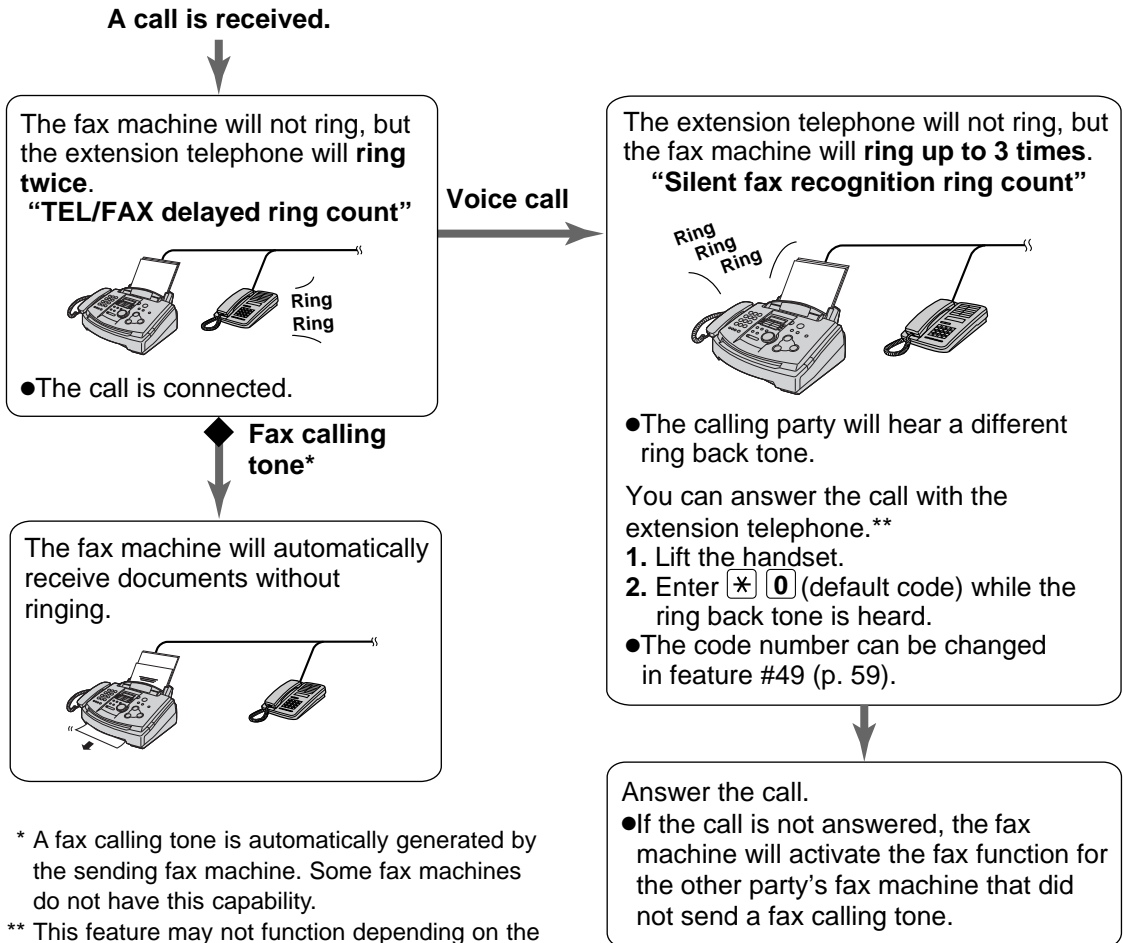

* A fax calling tone is automatically generated by the sending fax machine. Some fax machines do not have this capability.

** This feature may not function depending on the type of an extension telephone. If the fax machine activates the fax function, press **STOP** on the fax machine in step 2 to talk with the calling party.

TEL/FAX delayed ring count

The number of rings generated before the fax machine answers depends on the setting of feature #78 on page 61. The fax machine will not generate an audible ring during this time.

Silent fax recognition ring count

The fax machine generates audible rings to indicate that it is receiving a voice call. The number of rings generated depends on the setting of feature #30 on page 58. This signal will not ring at an extension telephone.

Receiving Faxes

Using with an answering machine and computer

We recommend that you always connect the fax machine directly to the wall jack.

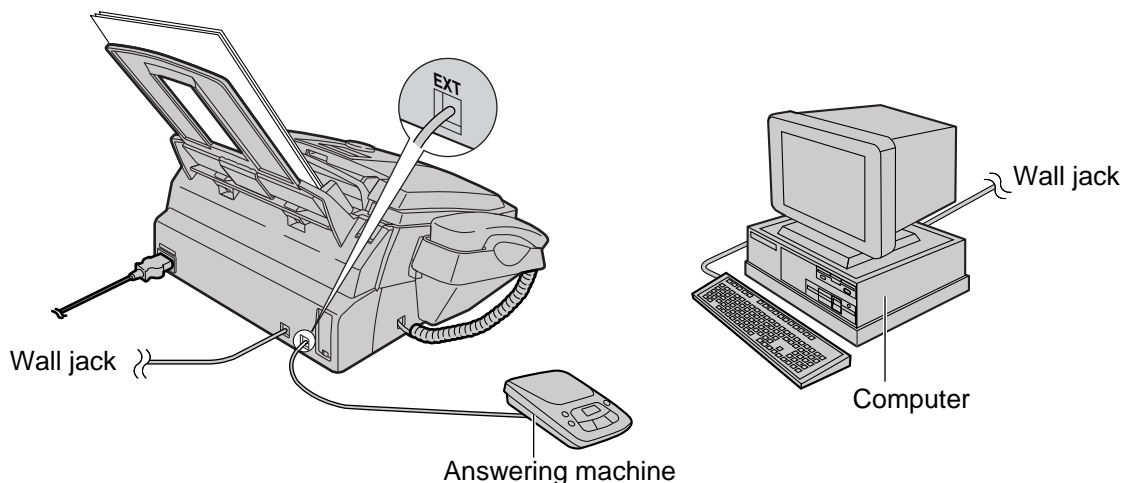

Note:

- Set the fax machine to TEL mode.
- The device which has the shortest ring count will answer a call first.
- If you use your computer as an answering machine, connect the telephone line cord from the EXT jack to the computer.

Extension telephone

If you use the fax machine with an extension telephone, you can receive fax documents using the extension telephone. You do not have to press **FAX START** on the fax machine.

Important:

- Use a touch tone telephone as the extension telephone and enter the fax activation code **firmly**.

1 When the extension telephone rings, lift the handset of the extension telephone.

2 When:
—document reception is required,
—a fax calling tone (slow beep) is heard, or
—no sound is heard,
press *** * * 9** (pre-selected fax activation code) **firmly**.

3 Hang up the handset.
•The fax machine will start reception.

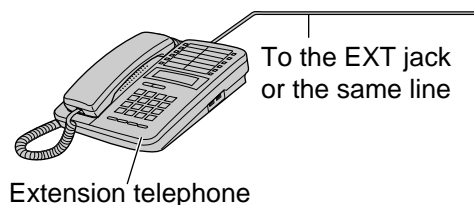

Note:

- You can change the fax activation code in feature #41 (p. 59).

Turning the AUTO ANSWER mode on remotely **≡**

When you are not in, and the AUTO ANSWER mode of your unit is set to off (TEL mode), you can turn the AUTO ANSWER mode (FAX ONLY or TEL/FAX mode) on from a remote location using a touch tone telephone.

1. Call your unit and wait for 10 rings.
 - You will hear a beep signal.
2. — **To switch to the FAX ONLY mode:**
Press ***7** within 8 seconds.
— **To switch to the TEL/FAX mode:**
Press ***8** within 8 seconds.
3. Hang up the handset.

Note:

- Press ***7** or ***8** within 8 seconds after hearing the beep, otherwise the call will be interrupted and the unit will remain in the TEL mode.

Receive polling **=====** (retrieving a fax placed on another fax machine)

This feature allows you to retrieve a document from another compatible machine. Therefore you pay for the call.

Make sure that no documents are fed into your unit and that the other party's machine is ready for your call.

- 1 Press **MENU** four times.
Display:
- 2 Press **SET**.
- 3 Dial the fax number.
Example:
- 4 Press **SET**.

- The unit will start reception.

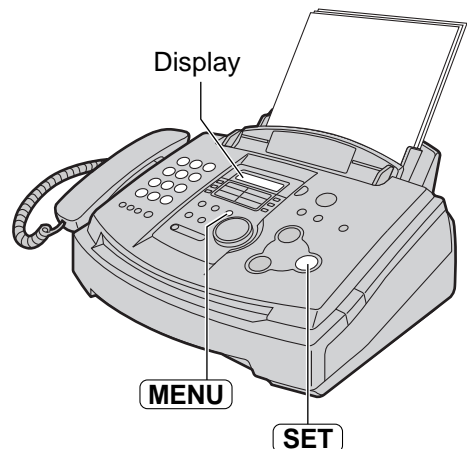

Receiving Faxes

Black list function

You can reject receiving facsimiles by registering the black list numbers. Up to 10 phone numbers can be stored as follows.

1 Press **[MENU]**.

Display: SYSTEM SET UP

2 Press **[FAX]**, then **[2]** **[7]**.

BLACK LIST

3 Press **[SET]**.

MODE=OFF ↻

4 Rotate **[EASY DIAL]** to select "ON".

MODE=ON ↻

- If this feature is not required, select "OFF".

5 Press **[SET]**.

NO. =

6 Enter the fax phone number you require as unauthorized number.

- You can enter a total of 22 digits.

NO. =5552233

7 Press **[SET]** to store.

NO. =

- To store other numbers, repeat from step 6.

8 Press **[MENU]**.

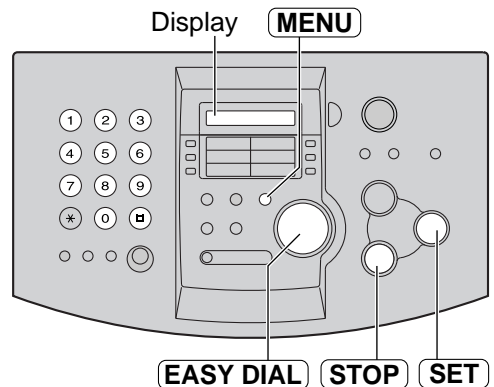

Note:

- If you make a mistake while programming, press **[STOP]**, then make the correction.
- To erase a programmed phone number, press **[STOP]** when the cursor is positioned on the first number in step 6.
- To confirm the programmed phone number, print out the setup list. See page 77.

Example:

SETUP LIST			
[ADVANCED FEATURE LIST]			
NO.	FEATURE	CURRENT SETTING	
#22	JOURNAL AUTO PRINT	ON	[ON,OFF]
#23	OVERSEAS MODE	OFF	[ON,OFF]
#25	DELAYED TRANSMISSION	OFF	[ON,OFF]
		DESTINATION =	
		START TIME =	12:00AM
#26	AUTO CALLER ID LIST	ON	[ON,OFF]
#27	BLACK LIST	ON	[ON,OFF]
	01 5552233	06 123123123	
	02 1234567890	07 456456456	
	03 11223344556	08	
	04 0987654321	09	
	05 369258147	10	

Black list numbers

Pager call - when the unit receives a fax

This feature allows your unit to call your pager when your unit receives a fax document.

1 Press **MENU** .
 Display: SYSTEM SET UP

2 Press **□**, then **7 0** .
 FAX PAGER CALL

3 Press **SET** .
 MODE=OFF ↻

4 Rotate **EASY DIAL** to select "ON".
 MODE=ON ↻

- If this feature is not required, select "OFF".

5 Press **SET** .
 NO. =

6 Enter your pager number.
 • You can enter a total of 46 digits and/or pauses.

Example:

1 202 555 1234PP12345678PP5555#

Your pager number

Pauses

Your pager access code, if required.

Message you want displayed on your pager

7 Press **SET** .
 • The unit will dial the stored number.
 PAGER TEST

8 Check that your pager receives a pager test call.

9 Press **MONITOR** .

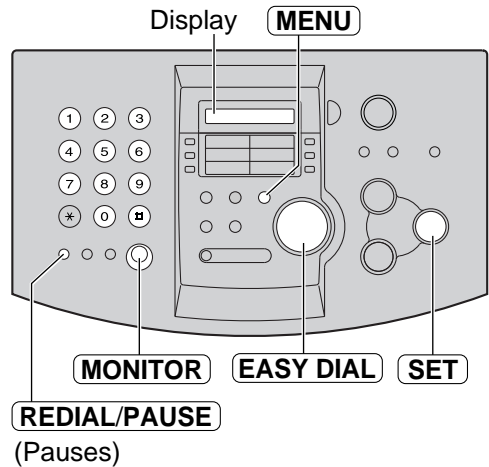

When your pager receives a pager call

Your pager will display the message you entered in step 6. (For example: 5555)

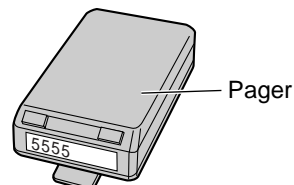

Copying

Making a copy

The unit can make single or multiple copies (up to 99).

- 1 Adjust the width of the document guides to the size of the document.
- 2 Insert the document (up to 15 pages) FACE DOWN until the unit grabs the document and a single beep is heard.

Display:

- Make sure the handset is on the cradle.

- 3 Press **COPY START** .

- If necessary, enter the number of copies (up to 99).

- 4 Press **COPY START** .
 - The unit will start copying.

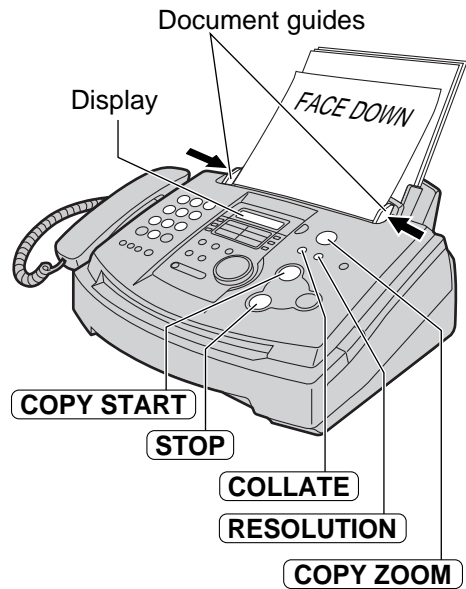

Note:

- Any transmittable document can be copied (p. 34).

To stop copying

Press **STOP** .

Convenient way to make a copy

The following settings are available before you start copying.

- Resolution
- Reduction/enlargement rate
- Collation (sort)

To select the resolution according to the type of document

Press **RESOLUTION** repeatedly to select the desired setting.

FINE: For printed or typewritten originals with small printing.

SUPER FINE: For originals with minute printing.

PHOTO: For originals containing photograph.

PHOTO WITH TEXT: For originals containing photograph and text.

Display while copying

- If you select "STANDARD", copying will be done using "FINE" mode.

To reduce or enlarge a document

To make a reduced copy, press

COPY ZOOM  repeatedly and select the desired reduction rate. The unit can reduce copies to as little as 50% of the original by changing the reduction rate 5% at a time.

Example: 70% reduced copy

Original document Reduced copy

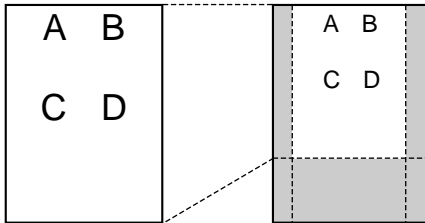

To make an enlarged copy, press

COPY ZOOM  repeatedly and select the desired enlargement rate. The unit can enlarge copies to as much as 200% of the original by changing the enlargement rate 5% at a time.

Example: 150% enlarged copy

Original document Enlarged copy

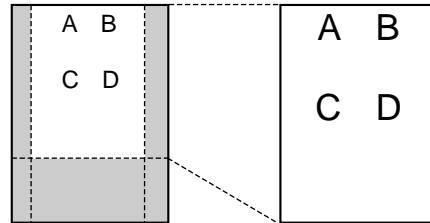

Note:

- The display will show the rate you selected while copying.

Example:

Reduction/enlargement rate

- For an enlarged copy, the unit will only enlarge the center of the upper part of the document. To make an enlarged copy of the bottom of the document, turn the document around, insert it into the unit, and then make a copy.

To collate multiple copies

The unit can collate multiple copies in the same order as the original document pages.

Press **COLLATE** until the following is displayed and start copying.

Display:

Example: Making two copies of a 4-page original document

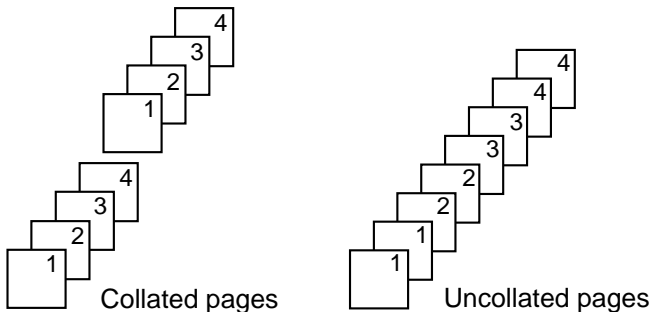

Note:

- The unit will store the documents into memory while collating copy. If memory becomes full while storing, the unit will only print out the stored pages.
- While collating copies, the display will show the following.

Example:

shows collating copy

Features Summary

Programming

The unit provides various programming features. Program the desired settings by referring to the programming tables (p. 55–61).

General programming method

1 Press **MENU**.

Display: SYSTEM SET UP

2 Select the feature you wish to program.

■ **For basic features** (p. 55, 56):

Rotate **EASY DIAL** until the desired feature is displayed.

■ **For advanced features** (p. 57–61):

Rotate **EASY DIAL** until the following is displayed.

ADVANCED MODE

Press **SET** and rotate **EASY DIAL** until the desired feature is displayed.

3 Press **SET**.

● The current setting of the feature will be displayed.

4 Rotate **EASY DIAL** until the desired setting is displayed.

● This step may be slightly different depending on the feature.

5 Press **SET**.

● The setting you selected is set, and the next feature will be displayed.

6 To exit programming, press **MENU**.

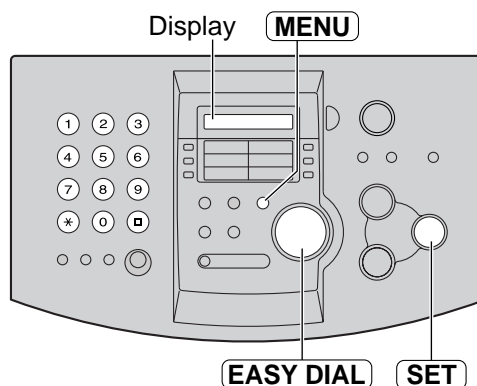

Programming by entering the program code number directly

You can select a feature by directly entering the program code (# and 2-digit number) instead of using **EASY DIAL**.

1. Press **MENU**.

2. Press **#** and the 2-digit code number.

3. Follow steps 3 to 6 above.

● See programming tables for code numbers (p. 55–61).

To cancel programming

Press **MENU** to exit the program.

Features Summary

Basic features

Programming table

Code	Display & Feature	Settings	How the unit operates
#01	<div style="border: 1px solid black; padding: 2px; width: fit-content;">SET DATE & TIME</div> To set the date and time.	mm/dd/yy hh:mm (2 digits for each entry)	See page 17 for details.
#02	<div style="border: 1px solid black; padding: 2px; width: fit-content;">YOUR LOGO</div> To set your logo.	(Up to 30 characters)	See page 18 for details.
#03	<div style="border: 1px solid black; padding: 2px; width: fit-content;">YOUR FAX NO.</div> To set your facsimile telephone number.	(Up to 20 digits)	See page 20 for details.
#04	<div style="border: 1px solid black; padding: 2px; width: fit-content;">SENDING REPORT</div> To print and check the sending report for fax transmission results (p. 35).	ERROR	“ERROR”: The sending report will be printed only when fax transmission fails. “ON”: The sending report will be printed out after every transmission.
		ON	
		OFF	
#06	<div style="border: 1px solid black; padding: 2px; width: fit-content;">FAX RING COUNT</div> To change the number of rings before the unit answers a call in FAX ONLY mode.	1, 2, 3, 4, 5, 6, 7, 8, 9	If you are using the unit with an answering machine, set to more than 4 (p. 44).

(The default setting is in bold type.)

Features Summary

Basic features (cont.)

How to set menu options

1. Press **MENU** .
2. Rotate **EASY DIAL** until the desired feature is displayed.
3. Press **SET** .
4. Rotate **EASY DIAL** until the desired setting is displayed.
5. Press **SET** .
6. Press **MENU** .

Note:

- Step 4 may be slightly different depending on the feature.
- See page 54 for more details.

Programming table (cont.)

Code	Display & Feature	Settings	How the unit operates
#12	<div style="border: 1px solid black; padding: 2px; display: inline-block;">REMOTE TAM ACT.</div> If you are using the unit with an answering machine, activate this feature, and set the remote activation ID to secure the remote operation for the answering machine.	ON / ID=11	To select "ON" and enter ID: 1. Press MENU . 2. Rotate EASY DIAL and select this feature. 3. Press SET . 4. Rotate EASY DIAL to select "ON". 5. Press SET . 6. Enter your ID from 1 to 5 digits, using 0–9, * and #. 7. Press SET . 8. Press MENU .
		OFF	
#13	<div style="border: 1px solid black; padding: 2px; display: inline-block;">DIALLING MODE</div> If you cannot dial, change the setting depending on your telephone line service.	TONE	"TONE": For tone dial service. "PULSE": For rotary pulse dial service.
		PULSE	
#17	<div style="border: 1px solid black; padding: 2px; display: inline-block;">MELODY RINGER</div> To set the ring melody.	BELL	You can select the bell or the melody. The selected bell or melody will sound while setting.
		MELODY (A, B, C, D)	

(The default setting is in bold type.)

Advanced features

How to set menu options

1. Press **MENU** .
2. Rotate **EASY DIAL** until the following is displayed.
 Display: ADVANCED MODE
3. Press **SET** .
4. Rotate **EASY DIAL** until the desired setting is displayed.
5. Press **SET** .
6. Press **MENU** .

Press **SET** and rotate **EASY DIAL** until the desired feature is displayed.

3. Press **SET** .

Note:

- Step 4 may be slightly different depending on the feature.
- See page 54 for more details.

Programming table

Code	Display & Feature	Settings	How the unit operates
#22	<div style="border: 1px solid black; padding: 2px; display: inline-block;">AUTO JOURNAL</div> To print the journal report automatically for fax communications.	ON	"ON": The unit will print the journal report automatically after every 30 new fax communications (p. 35).
		OFF	
#23	<div style="border: 1px solid black; padding: 2px; display: inline-block;">OVERSEAS MODE</div> If you have difficulty sending an overseas fax, activate this feature before starting transmission. This feature makes sending documents easier as the transmission speed is slowed down.	ON	After transmission, the unit will turn off automatically. ● This feature is not available for broadcast transmission. ● The calling charge may be higher.
		OFF	
#25	<div style="border: 1px solid black; padding: 2px; display: inline-block;">DELAYED SEND</div> To send a fax automatically at a specified time. This allows you to take advantage of low-cost calling hours offered by your telephone company. ● The setting can be reserved to take place up to 24 hours in advance.	ON / fax no. / hh:mm	To send a document: 1. Insert the document. 2. Follow steps 1–3 above. 3. Rotate EASY DIAL to select "ON". 4. Press SET . 5. Enter the fax number. 6. Press SET . 7. Enter the transmission start time. Press * to select "AM" or "PM". 8. Press SET . 9. Press MENU . ● To cancel after programming, press STOP then SET .
		OFF	
#26	<div style="border: 1px solid black; padding: 2px; display: inline-block;">AUTO CALL. LIST</div> To print the Caller ID list automatically.	ON	"ON": The unit will print the Caller ID list automatically after every 30 new calls (p. 29).
		OFF	

(The default setting is in bold type.)

Features Summary

Advanced features (cont.)

How to set menu options

1. Press **MENU**.
2. Rotate **EASY DIAL** until the following is displayed.
 Display: ADVANCED MODE
3. Press **SET**.
4. Rotate **EASY DIAL** until the desired setting is displayed.
5. Press **SET**.
6. Press **MENU**.

Press **SET** and rotate **EASY DIAL** until the desired feature is displayed.

Note:

- Step 4 may be slightly different depending on the feature.
- See page 54 for more details.

Programming table (cont.)

Code	Display & Feature	Settings	How the unit operates
#27	<div style="border: 1px solid black; padding: 2px; display: inline-block;">BLACK LIST</div> To set the black list function.	ON	See page 50 for details.
		OFF	
#30	<div style="border: 1px solid black; padding: 2px; display: inline-block;">SILENT FAX RING</div> To change the number of rings when the unit detects a voice call in TEL/FAX mode.	3 , 4, 5, 6, 7, 8, 9	See pages 46 and 47 for details.
#31	<div style="border: 1px solid black; padding: 2px; display: inline-block;">RING DETECTION</div> If you subscribe to a duplex ring service from your telephone company, activate this feature. • For more information on the availability of this service, please contact your telephone company before setting this feature on.	ON	The duplex ring service gives you an additional phone number on a single telephone line, with a different ringing pattern. When you wish to use the additional number as a fax, set this feature ON.
		OFF	
#37	<div style="border: 1px solid black; padding: 2px; display: inline-block;">AUTO REDUCTION</div> To receive a fax document that is longer than your recording paper.	ON	"ON": The unit will fit a received document onto your recording paper. "OFF": The unit will print the original size.
		OFF	
#39	<div style="border: 1px solid black; padding: 2px; display: inline-block;">LCD CONTRAST</div> To adjust the display contrast.	NORMAL	"NORMAL": For normal contrast "DARKER": Used when the display contrast is too light.
		DARKER	

(The default setting is in bold type.)

Features Summary

Code	Display & Feature	Settings	How the unit operates
#41	<div style="border: 1px solid black; padding: 2px; display: inline-block;">FAX ACTIVATION</div> If you use an extension telephone and wish to use it to receive a fax, activate this feature, and enter the code (p. 48). ● This code is also used to receive a voice message and a fax in the same call (p. 45).	ON / CODE= * * * 9	<ol style="list-style-type: none"> 1. Follow steps 1–3 on page 58. 2. Rotate EASY DIAL to select “ON”. 3. Press SET . 4. Enter your code from 2 to 4 digits, using 0–9 and * . 5. Press SET . 6. Press MENU . ● Do not enter “0000”.
		OFF	
#44	<div style="border: 1px solid black; padding: 2px; display: inline-block;">RECEIVE ALERT</div> To alert you with beeps when a received document is stored into memory due to a problem.	ON	If you hear slow beeps, clear the printing problem or supply paper to print the stored document. The beeps will stop.
		OFF	
#46	<div style="border: 1px solid black; padding: 2px; display: inline-block;">FRIENDLY RCV</div> To receive a fax automatically when you answer a call and hear a fax calling tone (slow beep).	ON	“ON”: You do not have to press FAX START for fax reception.
		OFF	
#49	<div style="border: 1px solid black; padding: 2px; display: inline-block;">AUTO DISCONNECT</div> To answer a call with an extension telephone in TEL/FAX mode (p. 47).	ON / CODE= * 0	<ol style="list-style-type: none"> 1. Follow steps 1–3 on page 58. 2. Rotate EASY DIAL to select “ON”. 3. Press SET . 4. Enter your code from 2 to 4 digits, using 0–9 and * . 5. Press SET . 6. Press MENU .
		OFF	
#58	<div style="border: 1px solid black; padding: 2px; display: inline-block;">ORIGINAL</div> To send or copy a document with faint or dark writing, set this feature before starting transmission or copying.	NORMAL	“NORMAL”: Used for normal writing. “LIGHT”: Used for faint writing. “DARKER”: Used for dark writing. ● This feature will return to the normal mode after transmission or copying.
		LIGHT	
		DARKER	

(The default setting is in bold type.)

Features Summary

Advanced features (cont.)

How to set menu options

1. Press **MENU** .
2. Rotate **EASY DIAL** until the following is displayed.
Display: ADVANCED MODE
3. Press **SET** .
4. Rotate **EASY DIAL** until the desired setting is displayed.
5. Press **SET** .
6. Press **MENU** .

Press **SET** and rotate **EASY DIAL** until the desired feature is displayed.

Note:

- Step 4 may be slightly different depending on the feature.
- See page 54 for more details.

Programming table (cont.)

Code	Display & Feature	Settings	How the unit operates
#68	<div style="border: 1px solid black; padding: 2px; display: inline-block;">ECM SELECTION</div> ECM stands for Error Correction Mode. To send a fax even if there is static interference on the telephone line.	ON	This feature is available when the transmitting/receiving stations are ECM compatible. • If documents are in memory, clear them before making the setting (p. 42).
		OFF	
#70	<div style="border: 1px solid black; padding: 2px; display: inline-block;">FAX PAGER CALL</div> If you have a pager and wish to know when your unit receives a fax, activate this feature.	ON	See page 51 for details.
		OFF	
#76	<div style="border: 1px solid black; padding: 2px; display: inline-block;">CONNECTING TONE</div> If you often have trouble when sending a fax, this feature allows you to hear connecting tones: fax tone, ring back tone and busy tone.	ON	You can confirm the status of the other party's machine. • If the ring back tone continues, the other party's machine may not be a facsimile or may have run out of paper. Check with the other party. • The connecting tone volume cannot be adjusted.
		OFF	

(The default setting is in bold type.)

Features Summary

Code	Display & Feature	Settings	How the unit operates
#77	<div style="border: 1px solid black; padding: 2px; display: inline-block;">AUTO ANSWER</div> To change the receive mode in the AUTO ANSWER setting.	FAX ONLY	"FAX ONLY": Facsimile only mode (p. 43) "TEL/FAX": Telephone/Facsimile mode (p. 46, 47)
		TEL/FAX	
#78	<div style="border: 1px solid black; padding: 2px; display: inline-block;">TEL/FAX RING</div> If you use an extension telephone in TEL/FAX mode, select the desired number of rings of the extension telephone.	1, 2 , 3, 4, 5, 6, 7, 8, 9	See pages 46 and 47 for details.
#79	<div style="border: 1px solid black; padding: 2px; display: inline-block;">TONER SAVE</div> To save on toner consumption.	ON	"ON": The toner cartridge will last longer. ● This feature may reduce print quality.
		OFF	
#80	<div style="border: 1px solid black; padding: 2px; display: inline-block;">SET DEFAULT</div> To reset on advanced features to their default settings.	YES	<ol style="list-style-type: none"> 1. Follow steps 1–3 on page 60. 2. Rotate EASY DIAL to select "YES". 3. Press SET . 4. Press SET again. 5. Press MENU .
		NO	

(The default setting is in bold type.)

Error Messages

Reports

If your unit cannot send a fax, check the following:

- the number you dialed is correct,
- the other party's machine is a facsimile.

If the problem remains, correct it by following the communication message printed on the sending and journal reports (p. 35).

Communication message	Error code	Cause & solution
COMMUNICATION ERROR	40–42 46–52 58, 65 68, 72 FF	●A transmission or reception error occurred. Try again or check with the other party.
	43 44	●A line problem occurred. Connect the telephone line cord to a different jack and try again. ●An overseas transmission error occurred. Try using the overseas mode of feature #23 (p. 57).
DOCUMENT JAMMED	—	●The document is jammed. Remove the jammed document (p. 69).
ERROR-NOT YOUR UNIT	54 59 70	●A transmission or reception error occurred because of a problem with the other party's fax machine. Check with the other party.
MEMORY FULL	—	●The document was not received due to memory being full.
NO DOCUMENT	—	●The document was not fed into the unit properly. Reinsert the document and try again.
OTHER FAX NOT RESPOND	—	●The other party's fax machine is busy or has run out of recording paper. Try again. ●The document was not fed properly. Reinsert the document and try again. ●The other party's fax machine rings too many times. Send the fax manually – dial the number, confirm the fax tone, and press (FAX START) . ●The other party's machine is not a facsimile. Check with the other party. ●The number you dialed is not in service.
PRESSED THE STOP KEY	—	● (STOP) was pressed and fax communication was canceled.
THE COVER WAS OPENED	—	●The front cover was opened. Close it and try again.
OK	—	●Fax communication was successful.

Display

If the unit detects a problem, one or more of the following messages will appear on the display.

Display message	Cause & solution
CALL SERVICE	●There is something wrong with the unit. Contact our service personnel.
CHANGE DRUM	●There is something wrong with the drum unit. Replace the drum unit and the toner cartridge (p. 74).
CHECK DOCUMENT	●The document was not fed into the unit properly. Reinsert the document. If misfeeding occurs frequently, clean the document feeder rollers (p. 72) and try again. If the problem remains, adjust the feeder pressure (p. 71).
CHECK DRUM	●The drum unit was not inserted properly. Reinsert it correctly (p. 12).
CHECK MEMORY	●Memory (telephone numbers, parameters, etc.) has been erased. Re-program.
COVER OPEN	●The front cover is open. Close it.
EASY DIAL FULL	●There is no space to store new stations in the EASY DIAL directory. Erase unnecessary stations (p. 25).
FAILED PICK UP	●Recording paper was not fed into the unit properly. Reinsert the recording paper (p. 71).
FAX IN MEMORY	●The unit has a document in memory. See the other displayed message instructions to print out the document.
FAX MEMORY FULL	●Memory is full of received documents due to a lack of recording paper or a recording paper jam. Install paper or clear the jammed paper. ●When performing memory transmission, the document being stored exceeds the memory capacity of the unit. Transmit the entire document manually.
MEMORY FULL	●When making a copy, the document being stored exceeds the memory capacity of the unit. Press (STOP) to clear the message. Divide the document into sections.
MODEM ERROR	●There is something wrong with the modem circuit. Contact our service personnel.

(continued)

Error Messages

Display message	Cause & solution
NO FAX REPLY	<ul style="list-style-type: none"> ●The other party's fax machine is busy or has run out of recording paper. Try again.
OUT OF PAPER	<ul style="list-style-type: none"> ●Recording paper is not installed or the unit has run out of paper. Install paper (p. 15). ●Recording paper is not fed into the unit properly. Reinstall paper (p. 15).
PAPER JAMMED	<ul style="list-style-type: none"> ●A recording paper jam occurred. Clear the jammed paper (p. 70).
PLEASE WAIT	<ul style="list-style-type: none"> ●The unit is warming up. Wait for a while.
POLLING ERROR	<ul style="list-style-type: none"> ●The other party's fax machine does not provide the polling function. Check with the other party.
REDIAL TIME OUT	<ul style="list-style-type: none"> ●The other party's fax machine is busy or has run out of recording paper. Try again.
REMOVE DOCUMENT	<ul style="list-style-type: none"> ●The document is jammed. Remove the jammed document (p. 69). ●Attempted to transmit a document longer than 600 mm (23⁵/₈"). Press STOP to remove the document. Divide the document into two or more sheets and try again.
TONER EMPTY	<ul style="list-style-type: none"> ●The toner cartridge is empty. Replace the toner cartridge (p. 74).
TONER LOW	<ul style="list-style-type: none"> ●The remaining toner is low. Replace the toner cartridge as soon as possible (p. 74). We recommend you replace the drum unit every third time you replace the toner cartridge. To check the drum life and quality, please print the printer test list (p. 77).
TRANSMIT ERROR	<ul style="list-style-type: none"> ●A transmission error occurred. Try again.
WRONG PAPER	<ul style="list-style-type: none"> ●The unit printed on paper which is shorter than A4 size paper. To prevent the drum unit from becoming dirty, use A4 size paper.

When a function does not work, check here before requesting help

General

Problem	Cause & solution
I cannot make and receive calls.	<ul style="list-style-type: none"> ●The power cord or telephone line cord is not connected. Check the connections (p. 16). ●If you used a splitter to connect the unit, remove the splitter and connect the unit to the wall jack directly. If the unit operates properly, check the splitter.
I cannot make calls.	<ul style="list-style-type: none"> ●The dialing mode setting is wrong. Change the setting of feature #13 (p. 56).
The unit does not work.	<ul style="list-style-type: none"> ●Disconnect the unit from the telephone line and connect the line to a known working telephone. If the working telephone operates properly, contact our service personnel to have the unit repaired. If the working telephone does not operate properly, contact your telephone company.
The unit does not ring.	<ul style="list-style-type: none"> ●The ringer volume is set to off. Adjust it (p. 21).
The other party complains they only hear a fax tone and cannot talk.	<ul style="list-style-type: none"> ●FAX ONLY mode is set. Tell the other party the number is only used for faxes. ●Change to TEL mode (p. 42) or TEL/FAX mode (p. 46).
The REDIAL/PAUSE button does not function properly.	<ul style="list-style-type: none"> ●If this button is pressed during dialing, a pause will be inserted. If pressed immediately after a dial tone is obtained, the last number dialed will be redialed.
The receive mode does not function properly.	<ul style="list-style-type: none"> ●A duplex ring pattern of feature #31 is set (p. 58). ●TEL/FAX mode is set (p. 46, 47).
During programming, I cannot enter the code or ID number.	<ul style="list-style-type: none"> ●All or part of the numbers are the same. Change the code or ID number of features #12 (p. 56), #41 and #49 (p. 59).
The unit beeps.	<ul style="list-style-type: none"> ●Recording paper has run out. Press STOP to stop the beeps and install paper.

Operations

Fax – sending

Problem	Cause & solution
I cannot send documents.	<ul style="list-style-type: none"> ●The telephone line cord is connected to the EXT jack on the unit. Connect to the LINE jack (p. 16). ●The other party's fax machine is busy or has run out of recording paper. Try again. ●The other party's machine is not a facsimile. Check with the other party. ●The other party's fax machine rings too many times. Send the fax manually – dial the number, confirm the fax tone, then press FAX START .
The other party complains that letters on their received document are distorted or not clear.	<ul style="list-style-type: none"> ●If your line has special telephone services such as call waiting, the service may have been activated during fax transmission. Connect the unit to a line that does not have these services. ●The extension telephone on the same line is off the hook. Hang up the extension telephone and try again. ●Try copying the document. If the copied image is clear, there may be something wrong with the other party's machine.
The other party complains that dirty patterns or black lines appear on their received document.	<ul style="list-style-type: none"> ●The glass or rollers are dirty. Clean them (p. 72).
I cannot make an international fax call.	<ul style="list-style-type: none"> ●Use the overseas transmission mode of feature #23 (p. 57). ●Add two pauses at the end of the telephone number or dial manually.

Fax – receiving



Problem	Cause & solution
I cannot receive documents.	<ul style="list-style-type: none"> ●The telephone line cord is connected to the EXT jack on the unit. Connect to the LINE jack (p. 16).
I cannot receive documents automatically.	<ul style="list-style-type: none"> ●The receive mode is set to TEL mode. Set to FAX ONLY mode (p. 43) or TEL/FAX mode (p. 46, 47). ●The time taken to answer the call is too long. Decrease the number of rings of features #06 (p. 55), #30 (p. 58) and #78 (p. 61).
The display shows the following message, but faxes are not received. <div style="border: 1px solid black; padding: 2px; width: fit-content; margin: 5px 0;">CONNECTING.....</div>	<ul style="list-style-type: none"> ●The incoming call is not a fax. Change the receive mode to TEL mode (p. 42).
A blank sheet is ejected.	<ul style="list-style-type: none"> ●The other party placed the document in their fax machine the wrong way. Check with the other party.
A white line or a dirty pattern appears on your recording paper.	<ul style="list-style-type: none"> ●The glass or rollers are dirty. Clean them (p. 72).

(continued)



Fax – receiving (cont.)

Problem	Cause & solution
The printing quality is poor.	<ul style="list-style-type: none"> ●The other party sent a faint document. Ask them to send a clearer copy of the document. ●Some paper has instructions recommending which side to print on. Try turning the paper over. ●You may have used paper with a cotton and/or fiber content that is over 20%, such as letterhead or resume paper. ●The remaining toner is low. Replace the toner cartridge (p. 74). ●We recommend you replace the drum unit every third time you replace the toner cartridge (p. 74). To check the drum life and quality, please print the printer test list (p. 77). ●The toner save mode of feature #79 is on (p. 61).

Receive mode

Problem	Cause & solution
I cannot select the desired receive mode.	<ul style="list-style-type: none"> ●If you want to set FAX ONLY or TEL/FAX mode: <ul style="list-style-type: none"> —select the desired mode using feature #77 (p. 61), and —press AUTO ANSWER to turn on the AUTO ANSWER light. ●If you want to set TEL mode: <ul style="list-style-type: none"> —press AUTO ANSWER to turn off the AUTO ANSWER light. <div style="display: flex; align-items: center; margin-top: 10px;"> <div style="margin-right: 10px;">ON·····</div>  </div> <div style="display: flex; align-items: center; margin-top: 10px;"> <div style="margin-right: 10px;">OFF·····</div>  </div>
The other party complains that they cannot send a document.	<ul style="list-style-type: none"> ●The unit is not in AUTO ANSWER mode. Press AUTO ANSWER to turn on the AUTO ANSWER light. <div style="display: flex; align-items: center; margin-top: 10px;"> <div style="margin-right: 10px;">ON·····</div>  </div>

Copying

Problem	Cause & solution
The unit does not make a copy.	<ul style="list-style-type: none"> ●You cannot make a copy during programming. Make the copy after programming or stop programming.
A black line, a white line or a dirty pattern appears on the copied document.	<ul style="list-style-type: none"> ●The glass or rollers are dirty. Clean them (p. 72).
The printing quality is poor. <div style="display: flex; justify-content: space-around; margin-top: 10px;"> <div style="text-align: center;"> Original  </div> <div style="text-align: center;"> Copy  </div> </div>	<ul style="list-style-type: none"> ●Some paper has instructions recommending which side to print on. Try turning the paper over. ●You may have used paper with a cotton and/or fiber content that is over 20%, such as letterhead or resume paper. ●The remaining toner is low. Replace the toner cartridge (p. 74). ●We recommend you replace the drum unit every third time you replace the toner cartridge (p. 74). To check the drum life and quality, please print the printer test list (p. 77). ●The toner save mode of feature #79 is on (p. 61).

Operations

Using an answering machine

Problem	Cause & solution
I cannot receive documents automatically.	<ul style="list-style-type: none"> Your greeting message on the answering machine is too long. Shorten the message (up to 10 seconds). The answering machine rings too many times. Set to 1 or 2 rings.
I cannot receive voice messages.	<ul style="list-style-type: none"> Check if the answering machine is turned on and connected to the fax machine properly (p. 44). Set the number of rings on the answering machine to 1 or 2.
I cannot retrieve recorded voice messages on the answering machine from a remote location.	<ul style="list-style-type: none"> You did not program your remote access code in your fax machine correctly. Program the same code that is programmed on the answering machine to the fax machine with feature #12 (p. 56).
I pressed the remote access code to access the answering machine remotely, but the line was disconnected.	<ul style="list-style-type: none"> The code may include “#” which is used for certain features provided by telephone companies. Change the code on the answering machine to another number which does not include “#”. Also change the code of the fax machine with feature #12 (p. 56).
Callers complain that they cannot send a document.	<ul style="list-style-type: none"> Your answering machine has run out of recording tape. Rewind the tape to record messages. You set the answering machine to only give a greeting message.

If a power failure occurs

- The unit will not function.
- Fax transmission and reception will be interrupted.
- If delayed transmission of feature #25 (p. 57) is programmed and the start time has passed during a power failure, transmission will be attempted soon after power is restored.
- If fax documents are stored in memory, they will be lost. When power is restored, a power down report will be printed out stating which contents in memory have been erased.

Sample of a power down report

POWER DOWN REPORT				
		POWER DOWN AT:Jan. 05 2001 04:30AM		
		RESTARTED AT:Jan. 05 2001 04:31AM		
		YOUR LOGO	:	
		YOUR FAX NO.	:	
<< WARNING >>				
CONTENTS HAVE BEEN CLEARED DUE TO POWER DOWN.				
FOR ADDITIONAL INFORMATION, PLEASE SEE THE JOURNAL REPORT.				
NO.	OTHER FACSIMILE	MODE	PAGES	FUNCTION
01	<FAX # NOT AVAIL.>	RCV	01	MEMORY RECEIVE

Document jams - sending

- 1 Push the front cover open button then open the front cover.



Caution:
The fuser unit gets hot.
Do not touch it.

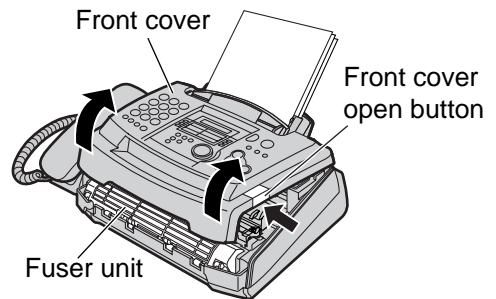

- 2 Pull down the middle guide while holding the front cover.

- 3 Remove the jammed document carefully.

- 4 Lift the middle guide firmly.

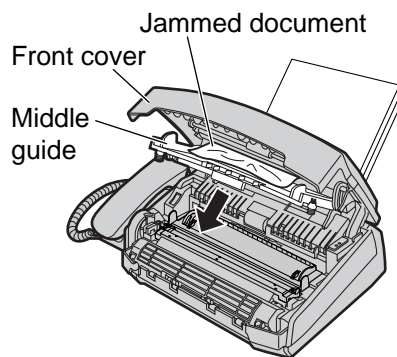

- 5 Close the front cover, until locked, by pushing down on both sides.

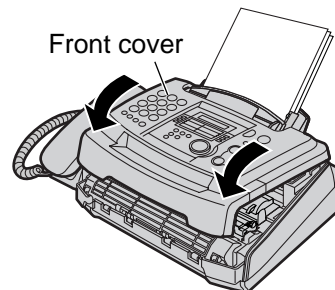

Note:

- Do not pull out the jammed document forcibly before opening the front cover.

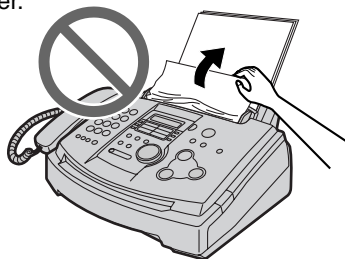

Recording paper jam

When the recording paper has jammed in the unit

The display will show the following message.

PAPER JAMMED

- 1 Push the front cover open button then open the front cover.



Caution:
The fuser unit gets hot.
Do not touch it.

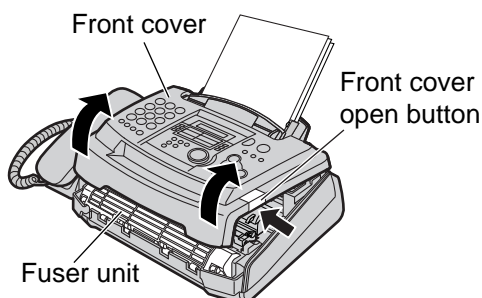

- 2 **When the recording paper has jammed near the drum and toner unit:**
Remove the jammed paper by pulling it toward you.

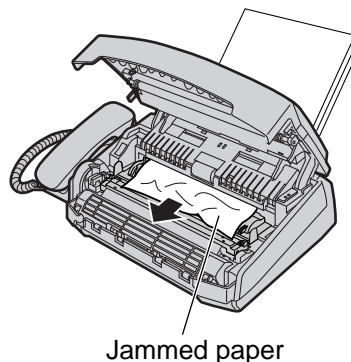

- When the recording paper has jammed near the recording paper exit:**
Remove the jammed paper by pulling it toward you.

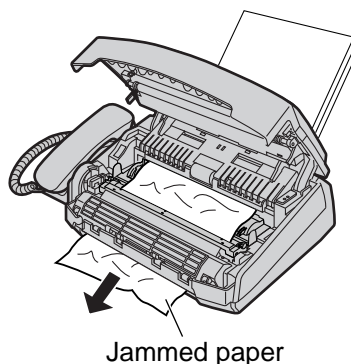

- 3 Close the front cover, until locked, by pushing down on both sides.

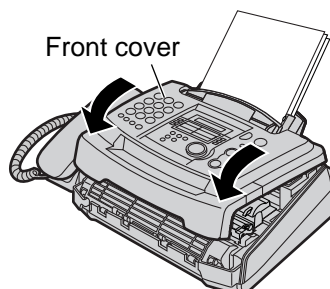

- 4** Remove the recording paper. Straighten and reinsert it into the recording paper entrance.



When the recording paper was not fed into the unit properly

The display will show the following message.

FAILED PICK UP

Remove the recording paper. Straighten and reinsert it into the recording paper entrance.



No feeding or multiple feeding occurs while sending

If no feeding or multiple feeding occurs frequently, adjust the feeder pressure.

Shift the position of the green lever by using a stick like instrument with a pointed end.

- Left:** When documents do not feed.
- Center:** Standard position (pre-selected)
- Right:** When documents multi-feed.

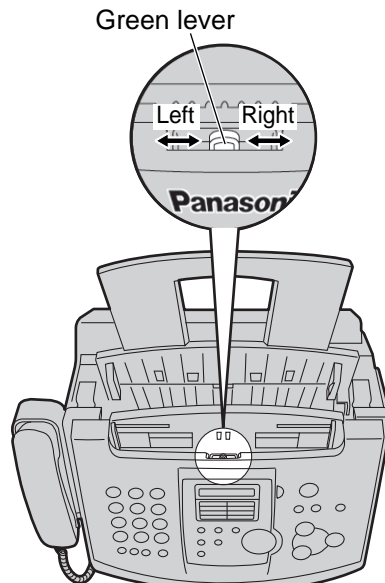

Cleaning

Cleaning the inside of the unit

If any of the following problems occurs, clean the inside of the unit:

- If misfeeding of your original occurs frequently.
- If a black line, a white line or a dirty pattern appears on your recording paper, on your original, or on the fax document received by the other party.

Caution:

●Be careful in handling the toner drum unit.

See the caution for the drum unit on page 74 for details.

●Do not use paper products, such as paper towels or tissues, to clean the inside of the unit.

1 Disconnect the power cord and the telephone line cord.

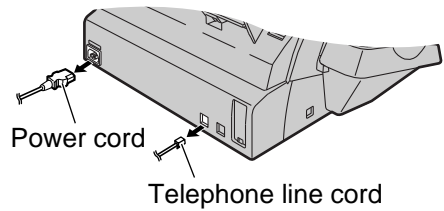

2 Push the front cover open button then open the front cover.



Caution:
The fuser unit gets hot.
Do not touch it.

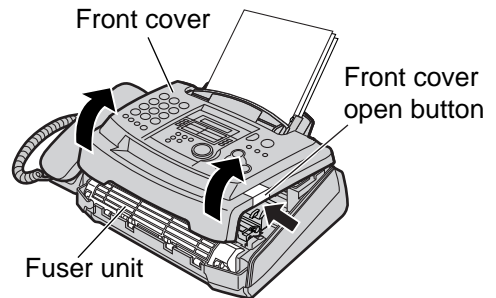

3 Pull down the middle guide while holding the front cover.

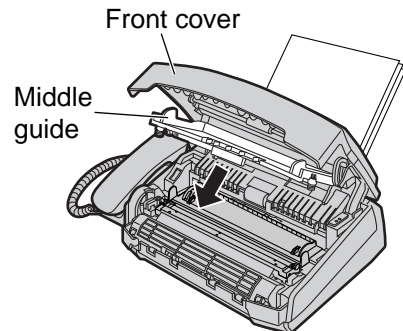

4 Clean the document feeder rollers with a cloth moistened with isopropyl rubbing alcohol, and let all parts dry thoroughly.

Clean the upper glass with a soft dry cloth.

5 Lift the middle guide firmly.

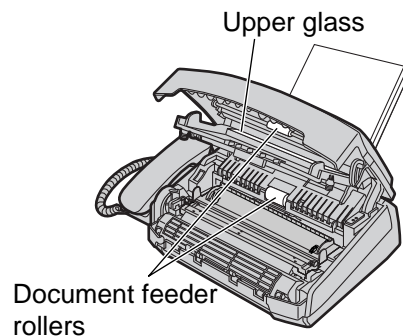

- 6** Remove the drum and toner unit by holding the two tabs.

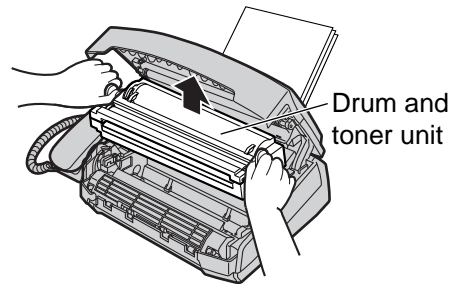

- 7** Clean the lower glass with a soft dry cloth.

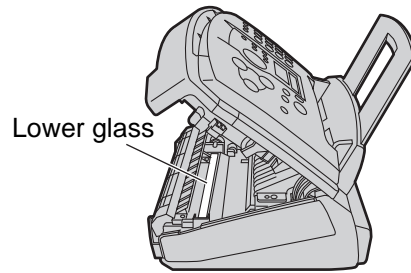

- 8** Reinstall the drum and toner unit by holding the tabs.

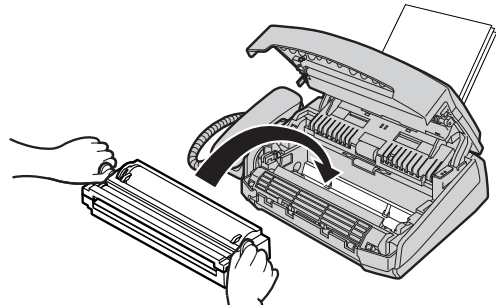

- 9** Close the front cover, until locked, by pushing down on both sides.

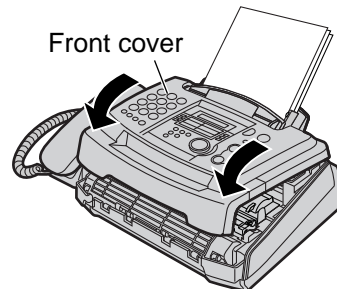

- 10** Reconnect the power cord and the telephone line cord.

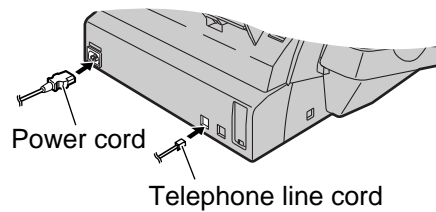

Replacement

Replacing the toner cartridge and the drum unit

■When the display shows the following message, replace the toner cartridge.

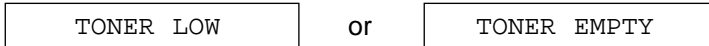

■We recommend you replace the drum unit every third time you replace the toner cartridge.
To check the drum life and quality, please print the printer test list (p. 77).

Model No. KX-FA76A toner cartridge and **Model No. KX-FA77A drum unit** are available for replacement (p. 8).

Caution:

●The drum unit contains a photosensitive drum. Exposing it to light may damage the drum.

Once you have opened the protection bag:

- Do not expose the drum unit to light for more than 5 minutes.
- Do not touch or scratch the green drum surface.
- Do not place the drum unit near dust or dirt, or in a high humidity area.
- Do not expose the drum unit to direct sunlight.

●Do not unplug the fax machine to prevent loss of fax documents in memory.

●Do not pour any toner into the toner cartridge.

- 1** Remove the new toner cartridge from the protection bag. Peel off the seal from the toner cartridge.

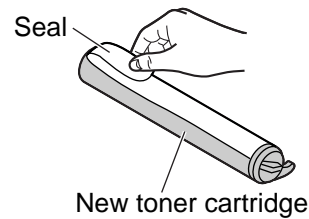

- 2** Push the front cover open button then open the front cover.



Caution:
The fuser unit gets hot.
Do not touch it.

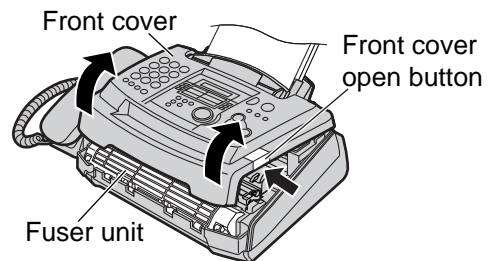

- 3** Tap on the used toner cartridge several times to allow the remaining toner to fall into the drum unit. Remove the drum and toner unit by holding the two tabs.

●If you replace the toner cartridge and the drum unit at the same time, skip to step 6.

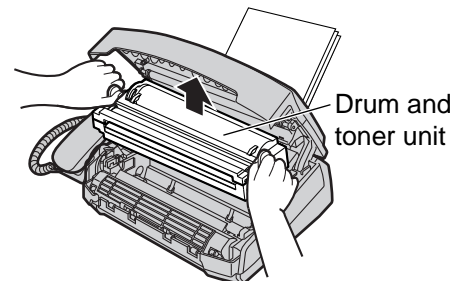

- 4** Turn the two levers on the used toner cartridge firmly.

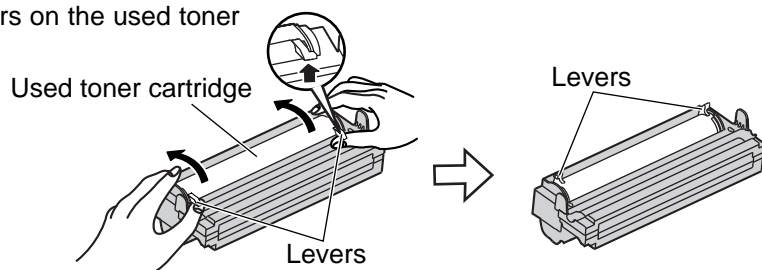

Replacement

5 Pull up the right edge of the used toner cartridge (①). Remove the cartridge from the drum unit (②).

- The toner may stick to the cartridge and the drum unit. Be careful in handling. See page 4 for details.
- Do not drop the toner on the green drum surface.
- Put the used toner cartridge into the protection bag.

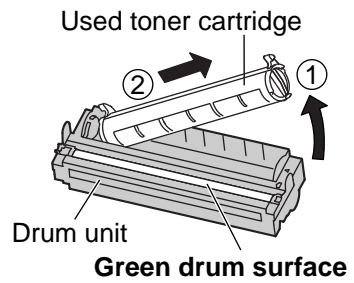

6 If you replace the drum unit at the same time, remove the new drum unit from the protection bag. Remove the protection bar from the drum unit.

With Panasonic face up on the toner cartridge, match the red arrows on the cartridge and the drum unit.

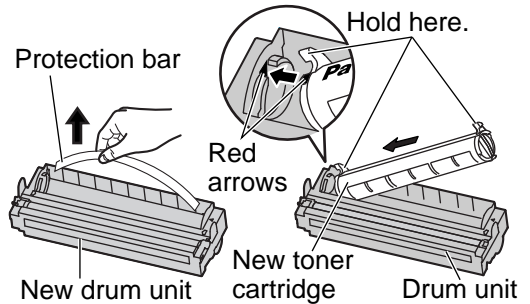

7 Slide the tab of the toner cartridge into the slot of the drum unit.

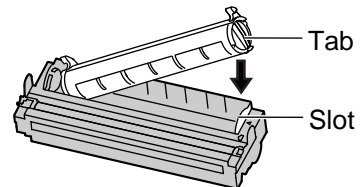

8a Hold right side of the toner cartridge under the lip on the drum unit and...

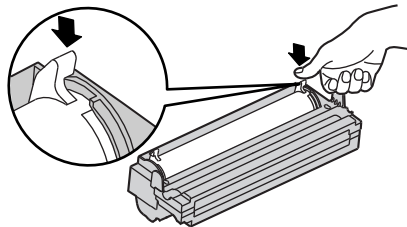

8b turn the two levers on the toner cartridge with firm pressure.

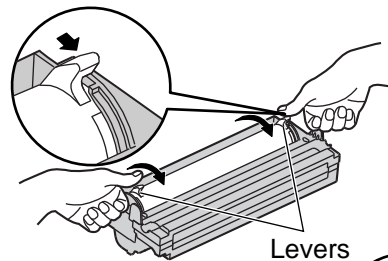

9 The toner cartridge is installed when the triangles match.

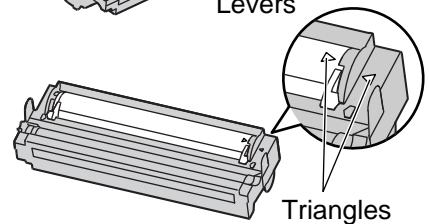

10 Tap on the toner cartridge several times to allow the toner to fall into the drum unit. Grab the tabs, and shake the drum and toner unit horizontally several times.

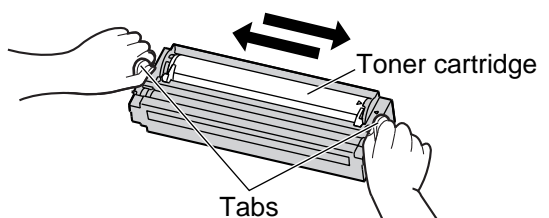

Replacement

11 Install the drum and toner unit by holding the tabs.

- If the lower glass is dirty, clean it with a soft dry cloth.

Lower glass

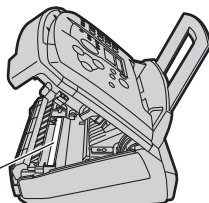

Drum and toner unit

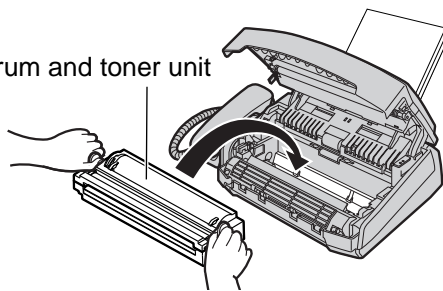

12 Close the front cover, until locked, by pushing down on both sides.

Waste disposal method

- Waste material may be dumped or incinerated under conditions which meet all country and local environmental regulations.

Front cover

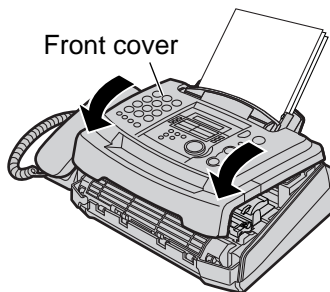

Reference lists and reports

You can print out the following lists and reports for your reference.

Setup list: provides you with the current settings of the basic and advanced programming features (p. 55–61).

Telephone number list: provides you with names and telephone numbers which are stored in ONE-TOUCH DIAL and EASY DIAL.

Journal report: keeps records of fax transmission and reception. This report will be printed automatically after every 30 fax communications (p. 35).

Broadcast programming list: provides you with items which are stored in the broadcast feature (p. 36).

Printer test list: allows you to check the print quality of your unit. If the test print has a dirty pattern, or blurred points or lines, clean the inside of the unit (p. 72). If printing quality is still poor, replace the toner cartridge and drum unit.

One-touch label card: provides you with names which are stored in the ONE-TOUCH DIAL keys (p. 22). You can put the card in the one-touch dial location.

1 Press **MENU** two times.

Display: PRINT REPORT

2 Rotate **EASY DIAL** until the desired item is displayed.

SETUP LIST

TEL NO. LIST

JOURNAL REPORT

BROADCAST LIST

PRINTER TEST

ONE-TOUCH LABEL

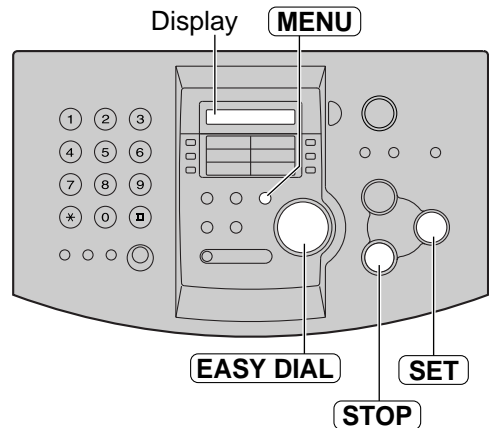

3 Press **SET** to start printing.

PRINTING

- To stop printing, press **STOP**.
- After printing, the printed item will be displayed.

4 Press **MENU**.

Specifications

Technical data about this product

Applicable Lines:	Public Switched Telephone Network
Document Size:	Max. 216 mm (8½") in width / Max. 600 mm (23⅝") in length
Effective Scanning Width:	208 mm (8⅜")
Recording Paper Size:	A4: 210 mm x 297 mm (8¼" x 11⅞")
Effective Printing Width:	202 mm (7⅞")
Transmission Time*:	Approx. 8 s/page (ECM-MMR)**
Scanning Density:	Horizontal: 8 pels/mm (203 pels/inch) Vertical: 3.85 lines/mm (98 lines/inch) –STANDARD 7.7 lines/mm (196 lines/inch) –FINE/PHOTO/PHOTO WITH TEXT 15.4 lines/mm (392 lines/inch) –SUPER FINE
Halftone Level:	64-level
Scanner Type:	Contact Image Sensor (CIS)
Printer Type:	Laser Beam Printer
Data Compression System:	Modified Huffman (MH), Modified READ (MR), Modified Modified READ (MMR)
Modem Speed:	14,400 / 12,000 / 9,600 / 7,200 / 4,800 / 2,400 bps; Automatic Fallback
Operating Environment:	10 °C – 32.5 °C (50 °F – 90.5 °F), 20 % – 80 % RH (Relative Humidity)
Dimensions (H x W x D):	190 mm x 417 mm x 345 mm (7½" x 16⅝" x 13⅝")
Mass (Weight):	Approx. 6.5 kg (14.3 lb.)
Power Consumption:	Standby: Approx. 7 W Transmission: Approx. 25 W Reception: Approx. 200 W Copy: Approx. 200 W Maximum: Approx. 560 W (When the fuser unit turns on)
Power Supply:	220–240 V AC, 50/60 Hz
Memory Capacity:	Approx. 120 pages of memory transmission Approx. 170 pages of memory reception (Based on the ITU-T No. 1 Test Chart in standard resolution.)
Laser diode properties:	Laser output: Max. 5 mW Wave length: 760 nm – 800 nm Emission duration: Continuous
Print Speed:	10 ppm (pages per minute)
Printing Resolution:	600 x 600 dpi

* Transmission speed depends upon the contents of the pages, resolution, telephone line conditions and capability of the other party's machine.

** Transmission speed is based upon the ITU-T No. 1 Test Chart and original mode.

If the capability of the other party's machine is inferior to your unit, the transmission time may be longer.

ITU-T No. 1 Test Chart

①

THE SLEREXE COMPANY LIMITED
SAPERS LAKE - BOULE - CORSEY - 88118 EA
NUMEROUS MODEL (MHS) 1011 - 1984 1008

Our Ref. 150/PSC/SAC 18th January, 1973.

Dr. P.F. Condon,
Milling Harveys Ltd.,
Millers Road,
Berke.

Dear Sirs,

Permit me to introduce you to the facility of facsimile transmission.

In facilitating a photofax is caused to perform a raster scan over the subject copy. The variation of pixel density on the document causes the photofax to generate an analogue electrical video signal. This signal is sent to produce a waveform which is transmitted to a remote destination over a radio or cable communication link.

At the remote terminal, demodulation reconstructs the video signal, which is used to modulate the density of paper produced by a printing device. This device is assumed to be a raster scan synchronised with that of the transmitting terminal. As a result, a facsimile copy of the subject document is produced.

Probably you have used our main facility in your organisation.

Yours sincerely,

P.F. Condon
P.F. CONDON
Group Leader - Facsimile Research

Toner life

Model No. KX-FA76A toner cartridge can print approx. 2,000 sheets of A4 size paper with a 5% image area. Toner life depends on the amount of content in a received, copied or printed document. The following is the approximate relationship between image area and toner life for Model No. KX-FA76A toner cartridge. Toner life varies in actual usage.

5% image area

Specifications	
Main unit specifications	
1. Applicable Lines:	Public switched telephone network
2. Compatibility:	ITU-TS G2
3. Effective Scanning Width:	Max. 206mm
4. Recording Paper Size:	Letter: 216 x 279mm Legal: 216 x 356mm
5. Effective Printing Width:	206mm
6. Transmission Time:	Approx. 35sec/page (3 Normal mode, M)
	Approx. 17sec/page (3 Original mode, M)
	Approx. 15sec/page (3 Original mode, M)
7. Fax Redial Times:	Up to 5 times
8. Telephone Redial Times:	Up to 35 times
9. Scanning Density:	Horizontal: 8dots/cm Vertical: 3.85 lines/cm (Standard mode) Vertical: 7.71 lines/cm (Fine or HalfFrame mode)
10. Scanner Type:	Contact image sensor

10% image area

Specifications	
Main unit specifications	
1. Applicable Lines:	Public switched telephone network
2. Compatibility:	ITU-TS G2
3. Effective Scanning Width:	Max. 206mm
4. Recording Paper Size:	Letter: 216 x 279mm Legal: 216 x 356mm
5. Effective Printing Width:	206mm
6. Transmission Time:	Approx. 35sec/page (3 Normal mode, M)
	Approx. 17sec/page (3 Original mode, M)
	Approx. 15sec/page (3 Original mode, M)
7. Fax Redial Times:	Up to 5 times
8. Telephone Redial Times:	Up to 35 times
9. Scanning Density:	Horizontal: 8dots/cm Vertical: 3.85 lines/cm (Standard mode) Vertical: 7.71 lines/cm (Fine or HalfFrame mode)
10. Scanner Type:	Contact image sensor
11. Printer Type:	Electrophotographic LED array printer
12. Data Compression System:	Modified Huffman (MH), Modified READ (MR)
13. Model Speed:	9600/2400/4800/2400bps
14. Operating Environment:	10-32.5 C 20-80%RH
15. Dimension (H x W):	371 x 462mm
16. Resolution (dpi):	Approx. 12x6
17. Power Consumption:	Standby: 12-48W Transmission: 12-48W Reception: 12-48W Copy: 24-50W Maximum: 60W

*Transmission Time: Transmission times apply to test data using ITU-TS No. 1 test chart between the same models at maximum speed and may vary in actual usage.

15% image area

Specifications	
Main unit specifications	
1. Applicable Lines:	Public switched telephone network
2. Compatibility:	ITU-TS G2
3. Effective Scanning Width:	Max. 206mm
4. Recording Paper Size:	Letter: 216 x 279mm Legal: 216 x 356mm
5. Effective Printing Width:	206mm
6. Transmission Time:	Approx. 35sec/page (3 Normal mode, M)
	Approx. 17sec/page (3 Original mode, M)
	Approx. 15sec/page (3 Original mode, M)
7. Fax Redial Times:	Up to 5 times
8. Telephone Redial Times:	Up to 35 times
9. Scanning Density:	Horizontal: 8dots/cm Vertical: 3.85 lines/cm (Standard mode) Vertical: 7.71 lines/cm (Fine or HalfFrame mode)
10. Scanner Type:	Contact image sensor
11. Printer Type:	Electrophotographic LED array printer
12. Data Compression System:	Modified Huffman (MH), Modified READ (MR)
13. Model Speed:	9600/2400/4800/2400bps
14. Operating Environment:	10-32.5 C 20-80%RH
15. Dimension (H x W):	371 x 462mm
16. Resolution (dpi):	Approx. 12x6
17. Power Consumption:	Standby: 12-48W Transmission: 12-48W Reception: 12-48W Copy: 24-50W Maximum: 60W

*Transmission Time: Transmission times apply to test data using ITU-TS No. 1 test chart between the same models at maximum speed and may vary in actual usage.

NOTE: The specifications are subject to change without notice.

Toner life for KX-FA76A

sheets 2,000

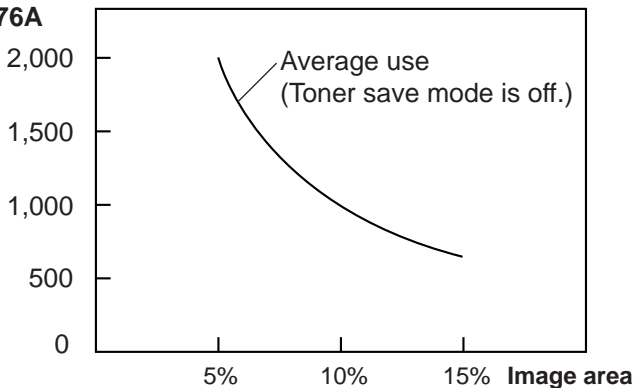

Note:

- The image area changes with the depth, thickness and size of the characters.
- If you change the toner save setting to on, the toner cartridge will last approx. 40% longer.

Drum life

The included drum unit or Model No. KX-FA77A can print approx. 6,000 sheets of A4 size paper regardless of the content of the image area.

Note:

- Any details given in these instructions are subject to change without notice.
- The pictures and illustrations in these instructions may vary slightly from the actual product.

Index

- A** Accessories 8
 - Advanced features 57–61
 - Answering machine 44
 - AUTO ANSWER button 42, 43, 46
 - Auto Answer setting (Feature #77) ... 61
 - Auto disconnection (Feature #49) ... 59
 - Auto reduction (Feature #37) ... 42, 58
- B** Basic features 55, 56
 - Black list (Feature #27) 50, 58
 - BROADCAST keys 36, 39
 - Broadcast sending report 39
 - Broadcast transmission 36
- C** Caller ID
 - (Calling back) 28
 - (Storing into directory) 30
 - Caller ID list (Feature #26) 29, 57
 - CALLER ID PRINT button 29
 - CALLER ID SEARCH button ... 28, 30
 - Character table 19
 - Cleaning 72
 - COLLATE button 53
 - Communication messages 62
 - Connecting tone (Feature #76) 60
 - Connections 16, 48
 - Copy 52
 - Copy reduction/enlargement 53
 - COPY ZOOM button 53
- D** Date and time (Feature #01) 17
 - Delayed transmission (Feature #25) . 57
 - Delete button 19
 - Dialing mode (Feature #13) 56
 - DIRECTORY PROGRAM button .22, 23
 - Display
 - (Contrast)(Feature #39) 58
 - (Error messages) 63, 64
 - Document jam 69
 - Document size 34
 - Document stacker 14
 - Drum life 79
 - Drum unit 12, 74
 - Duplex ring service
 - (Feature #31) 58
- E** EASY DIAL
 - (Making a voice call) 26
 - (Selecting characters) 19
 - (Sending faxes) 33
 - (Storing) 23
 - Error correction mode (Feature #68) .60
 - Error messages 62–64
 - Extension telephone 47, 48
- F** Facsimile telephone number
 - (Feature #03) 20
 - Fax activation code
 - (Feature #41) 45, 48, 59
 - Fax auto redial 33
 - FAX ONLY mode 43
 - Fax receiving 40, 41
 - Fax ring count (Feature #06) 55
 - Feeder pressure 71
 - Friendly reception (Feature #46) .42, 59
- H** HELP button 9
 - Hyphen button 19
- I** Insert button 19
- J** Jams 69–71
 - Journal report (Feature #22) ... 35, 57
- L** List
 - (Broadcast programming) 77
 - (Broadcast sending) 39
 - (Journal) 35, 77
 - (One-touch label) 22, 77
 - (Printer test) 77
 - (Sending) 35
 - (Setup) 77
 - (Telephone number) 77
 - Logo (Feature #02) 18
 - LOWER key 22, 26, 33
- M** MANUAL BROAD button 36
 - Melody ring (Feature #17) 21, 56
 - Memory reception 42
 - MONITOR button 32
 - Monitor volume 21
- N** NAME/TEL NO. button 26, 28

- O** One-touch dial
 - (Card)22, 77
 - (Making a voice call)26
 - (Sending faxes)33
 - (Storing)22
- Original mode (Feature #58)59
- Overseas mode (Feature #23)57
- P** Pager call (Feature #70)51, 60
- Paper jam70
- Paper stacker14
- Paper tray14
- Power down report68
- Power failure68
- Power supply78
- Q** QUICK SCAN START button32
- R** Receive polling49
- Receiving alert (Feature #44)59
- Receiving setting40, 41
- Recording paper15
- Recording paper size78
- REDIAL button32
- Remote activation ID (Feature #12) . . .56
- Report
 - (Broadcast sending)39
 - (Journal)35, 77
 - (Sending)35
- Reset (Feature #80)61
- RESOLUTION button32, 52
- Ring count
 - (FAX ONLY)(Feature #06)55
 - (Silent fax)(Feature #30)58
 - (TEL/FAX)(Feature #78)61
- Ring detection (Feature #31)58
- Ringer volume21
- S** Sending
 - (Broadcast)39
 - (EASY DIAL)33
 - (From memory)32
 - (Manually)32
 - (One-touch dial)33
- Sending report (Feature #04)35, 55
- Set default (Feature #80)61
- Silent fax recognition ring
 - (Feature #30)46, 47, 58
 - Specifications78
- Storing
 - (Broadcast key)36
 - (EASY DIAL)23
 - (One-touch dial)22
- T** TEL mode42
- TEL/FAX delayed ring count
 - (Feature #78)46, 47, 61
- TEL/FAX mode46
- Toner cartridge12, 74
- Toner life79
- Toner save (Feature #79)13, 61
- Transmission
 - (Broadcast)39
 - (EASY DIAL)33
 - (From memory)32
 - (Manually)32
 - (One-touch dial)33
- V** Voice contact31
- VOLUME button21

Kyushu Matsushita Electric Co., Ltd.

1-62, 4-chome, Minoshima, Hakata-ku, Fukuoka 812-8531, Japan